

K 1003.16

TM 9-280

WAR DEPARTMENT TECHNICAL MANUAL

Caliber .22 Rifles, All Types

WAR DEPARTMENT

•

16 MARCH 1944

Caliber .22 Rifles, All Types



WAR DEPARTMENT
Washington 25, D. C., 16 March 1944

TM 9-280, Caliber .22 Rifles, All Types, is published for the information and guidance of all concerned.

[A.G. 300.7 (3 Feb 44)]
[O.O. 300.7/1112]

BY ORDER OF THE SECRETARY OF WAR:

G. C. MARSHALL,
Chief of Staff.

OFFICIAL:

J. A. ULIO,
Major General,
The Adjutant General.

DISTRIBUTION: As prescribed in paragraph 9.a., FM 21-6; R and H (3); Bn 2, 4, 5, 7, 9-11, 17, 19 and 44 (1); C 2, 4, 5, 7, 9-11, 17, 19 and 44 (1).

(For explanation of symbols, see FM 21-6.)

CONTENTS

	Paragraphs	Pages
CHAPTER 1. INTRODUCTION	1- 5	4- 14
CHAPTER 2. DESCRIPTION AND FUNCTION- ING	6- 34	15- 83
SECTION I. General	6	15- 17
II. U.S. rifles, cal. .22, M1 and M2	7- 13	18- 41
III. Remington rifle, cal. .22, model 513T	14- 20	41- 54
IV. Stevens rifle, cal. .22, model 416-2	21- 27	54- 69
V. Winchester rifle, cal. .22, model 75	28- 34	69- 83
CHAPTER 3. OPERATION	35- 39	84- 90
CHAPTER 4. MALFUNCTIONS AND CORREC- TIONS	40- 41	91- 92
CHAPTER 5. CARE AND PRESERVATION ...	42- 48	93- 98
CHAPTER 6. DISASSEMBLY AND ASSEMBLY	49- 53	99-121
CHAPTER 7. INSPECTION	54- 61	122-125
CHAPTER 8. AMMUNITION FOR RIFLE, CAL. .22, ALL TYPES	62- 75	126-130
CHAPTER 9. ORGANIZATIONAL SPARE PARTS AND ACCESSORIES ..	76- 77	131-133
CHAPTER 10. STORAGE AND SHIPMENT ...	78- 80	134-135
CHAPTER 11. OPERATION UNDER UNUSUAL CONDITIONS	81- 82	136-137
CHAPTER 12. REFERENCES	83- 85	138-139
INDEX		140-143

*This Technical Manual supersedes TM 9-280, dated 1 October 1940.

CALIBER .22 RIFLES, ALL TYPES

CHAPTER 1

INTRODUCTION

1. SCOPE.

a. This manual is published for the information of the using arms and services. It contains a description of the cal. .22 target rifles, as well as technical information required for the identification, use, and care of the materiel. The rifles covered include the following:

Rifle, U.S., Cal. .22, M1922

Rifle, U.S., Cal. .22, M1 (figs. 1 and 2)

Rifle, U.S., Cal. .22, M2 (figs. 3 and 4)

Rifle, Cal. .22, Remington, Model 513T (figs. 5 and 6)

Rifle, Cal. .22, Stevens, Model 416-2 (figs. 7 and 8)

Rifle, Cal. .22, Winchester, Model 75 (figs. 9 and 10)

b. Disassembly, assembly, and such repairs as may be handled by using arm personnel may be undertaken only under the supervision of an officer or the chief mechanic.

c. In all cases where the nature of the repair, modification, or adjustment is beyond the scope or facilities of the unit, the responsible ordnance service should be informed so that trained personnel with suitable tools and equipment may be provided or proper instructions issued.

d. This manual differs from TM 9-280, U.S. Rifle, Cal. .22, M1922, M1922MI, and M2, dated 1 October 1940 as follows:

(1) In addition to the above rifles, it incorporates information required for the identification, use, and care of Remington Rifle, Cal. .22, Model 513T; Stevens Rifle, Cal. .22, Model 416-2, and Winchester Rifle, Cal. .22, Model 75.

(2) Chapters on malfunctions, inspection, limited storage, and operation under unusual conditions have been added.

(3) New illustrations have been included to clarify the text.

(4) All material has been revised to bring it up to present standards.

NOTE: The method of designation of parts of the rifles covered in this manual differ. Parts for the U.S. rifles are carried in SNL B-17 under regular ordnance part numbers and standard nomenclature. Parts for the Stevens and Winchester rifles are carried in SNL B-25 without either ordnance or manufacturer's part number, being designated only by standard nomenclature. Parts for the Remington rifle are carried in SNL B-25 under manufacturer's part number and standard nomenclature. In revised Standard Nomenclature Lists, the Remington manufacturer's part number will be preceded by the abbreviation "REM." In the future, parts of all rifles will be given

INTRODUCTION

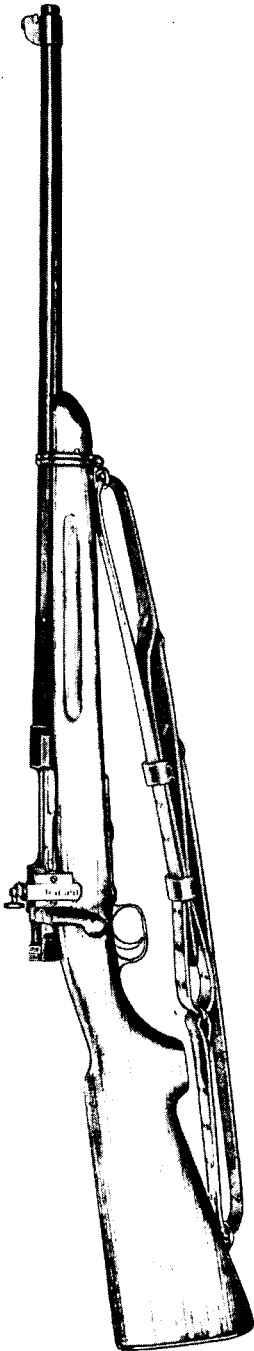

RA PD 81893

Figure 1 — U.S. Rifle, Cal. .22, M1 — Right-side View

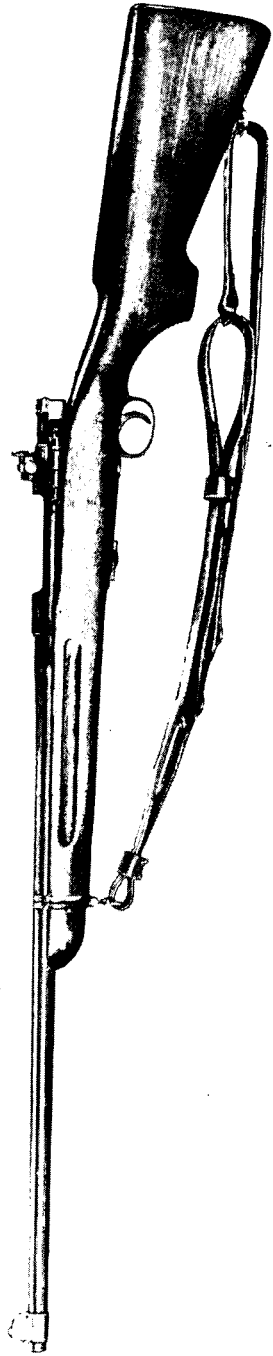

RA PD 81855

Figure 2 — U.S. Rifle, Cal. .22, M1 — Left-side View

CALIBER .22 RIFLES, ALL TYPES

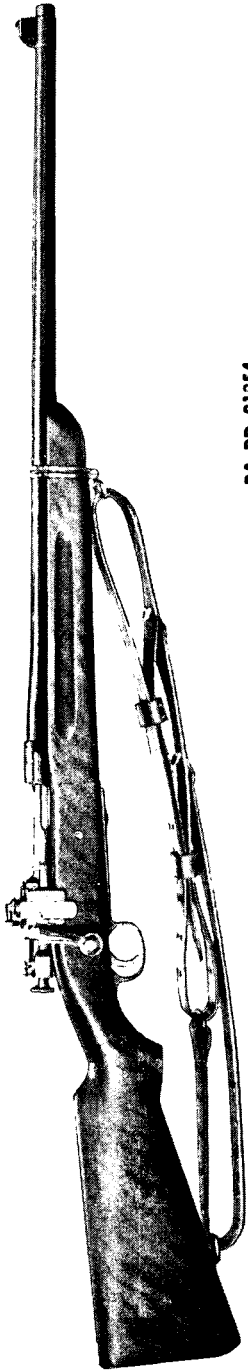

RA PD 81354

Figure 3 — U.S. Rifle, Cal. .22, M2 — Right-side View

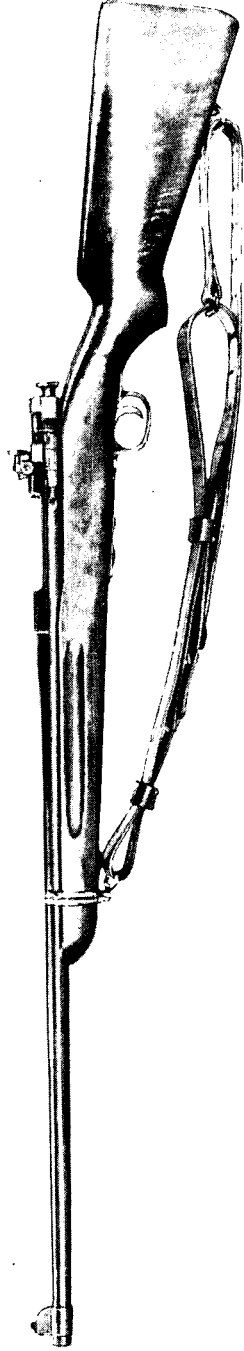

RA PD 81853

Figure 4 — U.S. Rifle, Cal. .22, M2 — Left-side View

INTRODUCTION

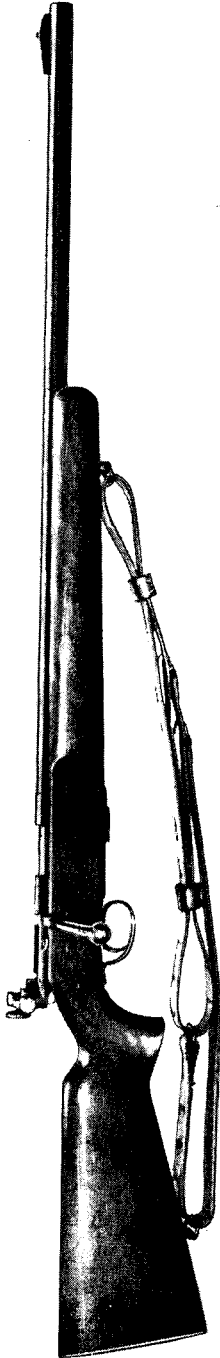

RA PD 81894
Figure 5 — Remington Rifle, Cal. .22, Model 513T — Right-side View

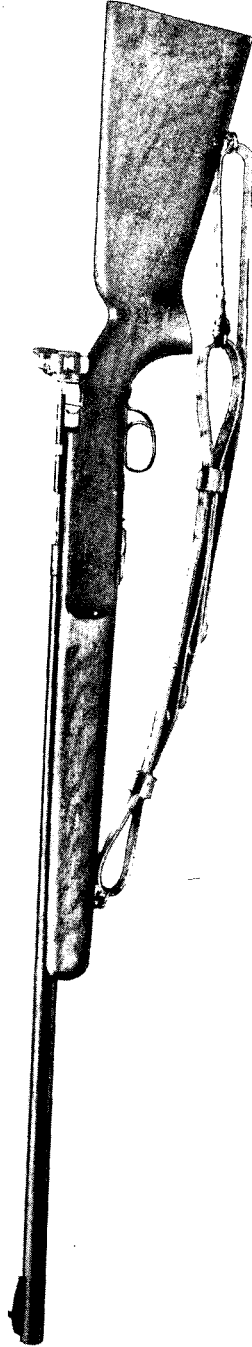

RA PD 81852
Figure 6 — Remington Rifle, Cal. .22, Model 513T — Left-side View

CALIBER .22 RIFLES, ALL TYPES

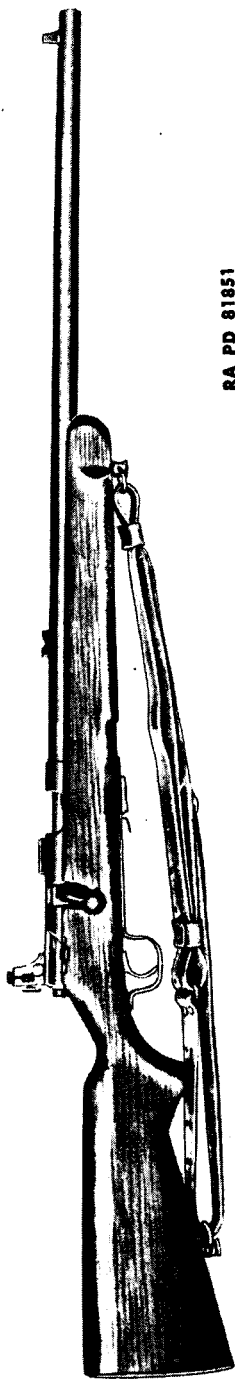

RA PD 81851

Figure 7 — Stevens Rifle, Cal. .22, Model 416-2 — Right-side View

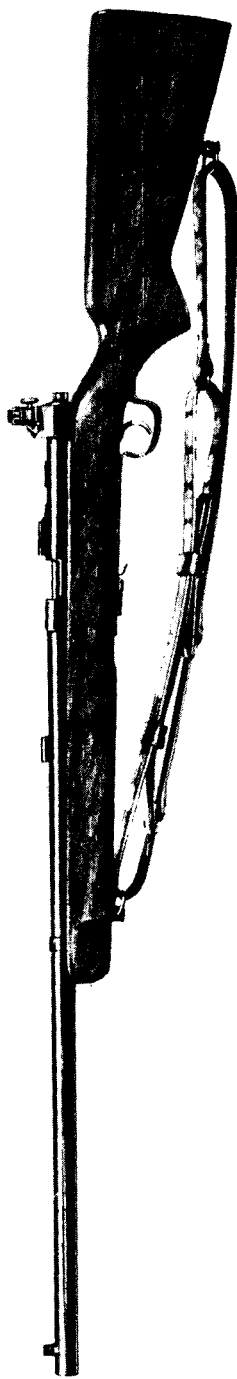

RA PD 81850

Figure 8 — Stevens Rifle, Cal. .22, Model 416-2 — Left-side View

INTRODUCTION

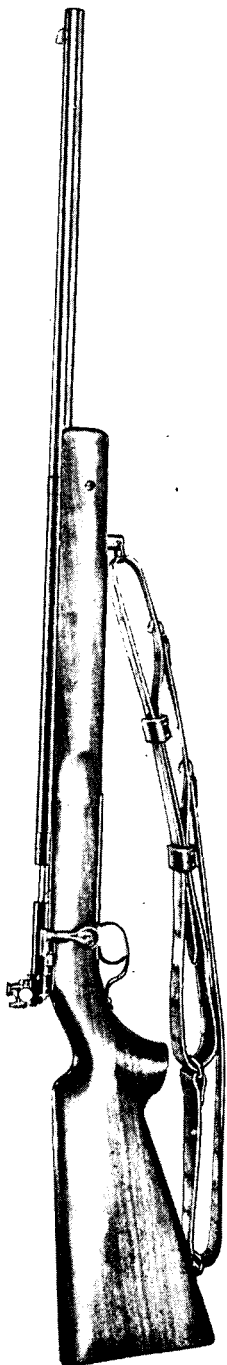

RA PD 81849

Figure 9 — Winchester Rifle, Cal. .22, Model 75 — Right-side View

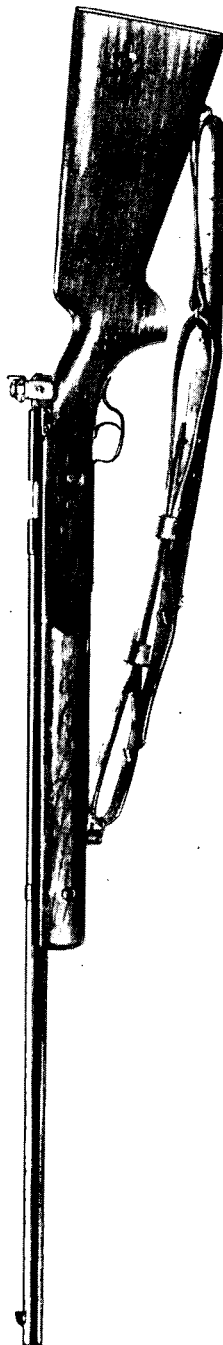

RA PD 81952

Figure 10 — Winchester Rifle, Cal. .22, Model 75 — Left-side View

CALIBER .22 RIFLES, ALL TYPES

ordnance stock numbers for storage purposes, in addition to any ordnance or manufacturer's part numbers and/or standard nomenclature by which they may be designated.

2. CHARACTERISTICS.

a. **General.** The purpose was to provide an accurate small-bore weapon for training purposes. Six types of these rifles have been produced to date; three U.S. rifles, and three commercial rifles, as listed in paragraph 1 a.

b. **Loading.** These rifles are magazine fed weapons of the bolt type. The magazine will hold five cartridges and one additional cartridge may be inserted into the chamber, making the maximum capacity, for any one loading, six shots. A cartridge is extracted, ejected, and a new one inserted by drawing the bolt back and closing it again.

c. **Rear Sights.** The rear sights are adjustable for windage and elevation.

3. DIFFERENCES AMONG MODELS.

a. **General.** The caliber .22 pattern of U.S. rifle described in this manual was initially developed by the Ordnance Department to provide an accurate small-bore weapon for use of civilian rifle clubs, for use in rifle competitions in schools and colleges, and for sales purpose to members of the National Rifle Association. Subsequently, the weapon was adopted for use in small-bore rifle marksmanship courses throughout the Army, Navy, Marine Corps, and Coast Guard. The rifles assembled for use of rifle clubs have the NRA type of stocks and butt plates (shotgun type), while those assembled for military use have the military type of stocks and butt plates.

b. **U.S. Rifle, Cal. .22, M1922.** As initially produced, this rifle was designated as RIFLE, U.S., caliber .22, M1922. Successive improvements have been indicated by the designations M1922MI (later changed to M1) and M2. In general, these changes in designation were caused by major improvements in the bolt and firing mechanism, and may be applied to any model. The original design of this rifle contained the M1922 Bolt Assembly which included a double-point striker and headed cocking piece, the M1922 Magazine Assembly which projected below the floor plate, and a No. 48B Lyman receiver sight. This sight has five graduations to one complete revolution of the elevating and windage screw knobs. Most of these rifles were assembled with the NRA type of stock (stock, M1922, assembly) and shotgun type of butt plate (plate, butt, M1922). Nearly all these rifles now have later type bolts and magazines, and the sights have been changed to the No. 48C Lyman receiver sight in general use on subsequent models. Therefore, the M1922 Rifle will not be covered further in this manual.

INTRODUCTION

c. U.S. Rifle, Cal. .22, M1. This rifle, formerly designated as the M1922MI, was the result of the first improvement to the M1922 Rifle, and included the bolt with the M1 Firing Mechanism Assembly, the M1 Magazine Assembly, and the No. 48C Lyman receiver sight. The improved bolt permitted more accurate head space adjustment which is critical in such small-bore weapons. The new magazine was made to set flush with the floor plate, and the new sight provided 10 graduations to 1 complete revolution of the elevating and windage screws. All these improvements may and probably have been applied to all M1922 Rifles except those sold to individuals.

NOTE: U.S. Rifle, Cal. .22, M1922MI (NRA) is identical with the regular M1922MI Rifle in so far as markings are concerned, but is assembled to the M1922 Stock Assembly D1823 which takes the M1922 Butt Plate. As already stated, the original designation of M1929MI was changed to M1. However, there are doubtless many rifles in the field with the old M1922MI marking. References to the M1 Rifle in this manual should be considered as also applying to rifles marked M1922MI.

d. U.S. Rifle, Cal. .22, M2.

(1) This rifle is the result of the second improvement of the original M1922 rifle. The improvements were made in two stages:

(a) The first stage included a redesigned bolt with firing mechanism assembly, magazine assembly, and stock assembly which were designated as M2. Approximately 3,800 rifles were so assembled.

(b) The second stage was a redesign of the bolt handle to incorporate an adjustable head space feature, composed of an head space adjusting screw and set screw. In addition, the fall of the firing pin was reduced to one-half that of the previous model, and the bolt head and magazine were modified to permit the uppermost cartridge to be in line with the chamber, thus reducing feed jams.

NOTE: Bolt handles of the first-stage design will be replaced with latest design bolt handles containing the adjustable head space feature as the rifles containing them are turned in for overhaul.

(2) A later modification of the bolt handle with adjustable head space feature slightly modified the bolt handle and head space adjusting screw, and substituted a copper locking plug for the set screw. Both adjusting screw and locking plug were sealed in place after adjustment.

(3) A still later modification of the bolt handle group changed the head space adjusting screw from one with a slotted head to one with an "Allen" set screw type of head, and eliminated the sealing of the screw and locking plug after adjustment.

(4) The M2 Bolt (with firing mechanism, assembly) and M2 Magazine Assembly may be used *together* in the M1922 and M1 Rifles. When so used, regardless of type of stock, the rifles will be marked as follows:

CALIBER .22 RIFLES, ALL TYPES



RA PD 81841

**Figure 11 – Blade Type Front Sight of Stevens Rifle,
Cal. .22, Model 416-2**

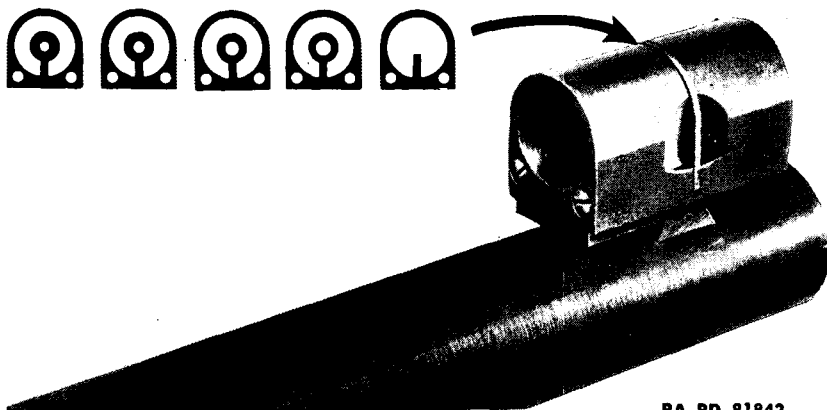

RA PD 81842

**Figure 12 – Hood Type Front Sight of Stevens Rifle,
Cal. .22, Model 416-2**

RIFLE, U.S. cal. .22, M1922M2 (adding "M2" to original marking)

RIFLE, U.S. cal. .22, MII (adding "I" to original marking)

In addition to above marking, there will also be added to serial numbers of the converted M1922 and M1 Rifles the letters "A" and "B" respectively.

NOTE: Rifles originally stamped as M1922MI will have marking M1922MII, and the letter "B" after the serial number when so converted.

(5) As the No. 48B and C Lyman receiver sights are practically identical except as stated above, parts of the C-sight will be requisitioned when replacement parts for repair are needed for either the B- or C-sight.

e. **Commercial Rifles.** The commercial rifles, Remington Model 513T, Stevens Model 416-2, and Winchester Model 75 are basically the same as the M1 and M2 Rifles. All are of bolt action type, have

INTRODUCTION

a magazine feed, and are equipped with rear sights adjustable for elevation and windage. Front sights are of the blade type except the Stevens which may be issued with either a blade type front sight (fig. 11) or a hooded type with five inserts (fig. 12). The differences in these rifles are tabulated below:

Characteristics	M1	M2	Remington 513T	Stevens 416-2	Winchester 75
Trigger pull . . .	Double pull	Double pull	Single	Single	Single
Adjustable pull . . .	None	None	Yes	None	Yes
Ejector	In bolt	In bolt	Fixed	Fixed	Fixed
Extractor	Single	Single	Double	Double	Double
Rear sight	Lyman 48C	Lyman 48C	Redfield 75-RT	Stevens	Lyman 57E
Front sight	Blade	Blade	Blade	Hood or Blade	Blade
Front swivel	Fixed	Fixed	Adjustable	Adjustable	Adjustable
Barrel band	Yes	Yes	None	None*	Yes

*Late models have band.

4. DATA.

	M1	M2	Remington 513T	Stevens 416-2	Winchester 75
Weight (lb)	8.75	8.90	8.20	8.70	7.90
Length (over-all) (in.)	43.7	43.7	45.0	45.8	45.0
Length of barrel (in.)	24.00	24.00	27.00	26.12	28.12
Length of rifling (in.)	23.35	23.35	26.25	25.35	27.32
Rifling—number of grooves	4	4	6	6	6
Rifling—RH twist: 1 turn in (in.)	16	16	16	16	16
Rifling—depth of grooves— (in.)	0.0025	0.0025	0.0025	0.0025	0.0025
	M1	M2	Remington 513T	Stevens 416-2	Winchester 75
Cross sectional area of bore (sq in.)	0.0385	0.0385	0.0383	0.0383	0.0383
Loading device	Magazine	Magazine	Magazine	Magazine	Magazine
Type of mech- anism	Bolt	Bolt	Bolt	Bolt	Bolt
Sight radius (in.)	28.4	28.4	33.4	32.8	32.8
Trigger pull (lb)	3.5 to 5	3.5 to 5	4 to 6	4 to 6	4 to 6
Normal pressure (lb per sq in.)	20,000	20,000	20,000	20,000	20,000
Ammunition types	22 long rifle	22 long rifle	22 long rifle	22 long rifle	22 long rifle
Approximate maximum range for car- tridge (yd)	1,500	1,500	1,500	1,500	1,500
Muzzle velocity (ft per sec)	1,100	1,100	1,100	1,100	1,100
Height of front sight from center of bore (in.)	1.067	1.067	0.832	0.828 (blade type) 0.878 (hood type)	1.195

CALIBER .22 RIFLES, ALL TYPES

5. CAUTIONS.

a. Do not snap the trigger of the U.S. Rifle M1 unnecessarily without a cartridge in the chamber, as this may result in injury to the firing pin. For practice purposes, a fired cartridge case should be placed in the chamber. The trigger of the other rifles may be snapped when the chamber is empty without causing damage.

b. Before firing rifle for record, push a dry patch through the bore, then fire two or three so-called fouling shots to warm the barrel, as an oily barrel will generally give a wild shot.

c. To insure a reasonably accurate life for the rifle, the utmost care to prevent corrosion or rusting of the bore should be taken. After firing the rifle, the barrel should be cleaned as soon as possible. In no case should the rifle be allowed to stand overnight without cleaning.

d. Never rest the rifle on the rear sight.

e. In case of misfire, the bolt should not be opened for about 15 seconds as it may be a hangfire.

f. Only authorized ammunition will be used. Cartridges other than the type for which the rifle is designed may so affect accuracy as to render the rifle unfit for use.

g. When a cartridge jams during loading, no effort should be made to force the cartridge into the rifle chamber. The bolt should be retracted and the feedway cleared by removing the jammed cartridge. Cases are on record of serious injury to personnel due to attempts to force the cartridge into the chamber, using undue force to close the bolt, or by striking the bolt handle (par. 65 a).

h. When inserting a cartridge into the chamber by hand, it is essential from a safety standpoint that the cartridge be fully chambered *by hand* before closing the bolt. Merely starting the cartridge in the chamber and then attempting to complete the operation with the bolt has resulted in serious injury to personnel.

i. If it is desired to carry the rifle cocked with a cartridge in the chamber, the firing mechanism should be secured by turning the safety to the "safe" position.

j. To obtain positive ejection, the bolt must be drawn fully to the rear with a quick motion so that the cartridge case will strike the ejector smartly.

k. It is essential for proper working and preservation of all cams that they be kept lubricated.

l. Never fire the rifle with rust-preventive compound or any obstruction, whether near the breech or the muzzle, in the bore.

m. When a stoppage occurs with this rifle, the feedway will be cleared by removal of the jammed cartridge, and under no circumstances will the firer attempt to force cartridge into rifle chamber by striking bolt handle or by using undue force to close bolt.

CHAPTER 2

DESCRIPTION AND FUNCTIONING

Section I

GENERAL

6. GENERAL.

a. For convenience, the parts of the rifles have been listed together in groups and assemblies. A group consists of a number of parts, or parts and assemblies, which function together and are so closely related to each other that they should be considered together. An assembly consists of two or more parts and/or assemblies which are either permanently or semipermanently assembled together and so carried in the Standard Nomenclature List 2 and so stored. An assembly frequently is issued as a unit for replacement purposes.

b. Any of the caliber .22 rifles covered in this manual may be disassembled into five groups of parts and/or assemblies: bolt (and firing mechanism) group; magazine group; rear sight group; barrel and receiver group; and stock group. For convenience and clarity, the description and functioning of each rifle is covered according to these five groups. Where a complete group is carried as an assembly, it is referred to as an assembly.

c. Nomenclature of like parts, assemblies or groups, composing the rifles covered in this manual, vary somewhat. For example, the bolt groups are designated either as groups or assemblies according to how they are carried in the Standard Nomenclature List pertaining to the rifles. The bolt group of the U.S. rifles is termed "bolt with firing mechanism assembly," that of the Winchester Model 75 rifle as "breech bolt assembly," that of the Stevens Model 416-2 rifle as "bolt assembly," that of the Remington Model 513T rifle is not designated as an assembly in the Standard Nomenclature List and is therefore called a "group" in this manual. However the completely assembled bolt of this latter rifle may be issued as a complete assembly. For convenience, such complete bolt assemblies or groups are sometimes referred to in this manual as the "bolt," as in chapters on "Operation," and "Disassembly and Assembly." Likewise the magazine assembly is referred to as the "magazine."

NOTE: At present, there are no organizational spare parts for the commercial rifles issued to the using arms. Such rifles must be sent to an arsenal for other than minor repair.

CALIBER .22 RIFLES, ALL TYPES

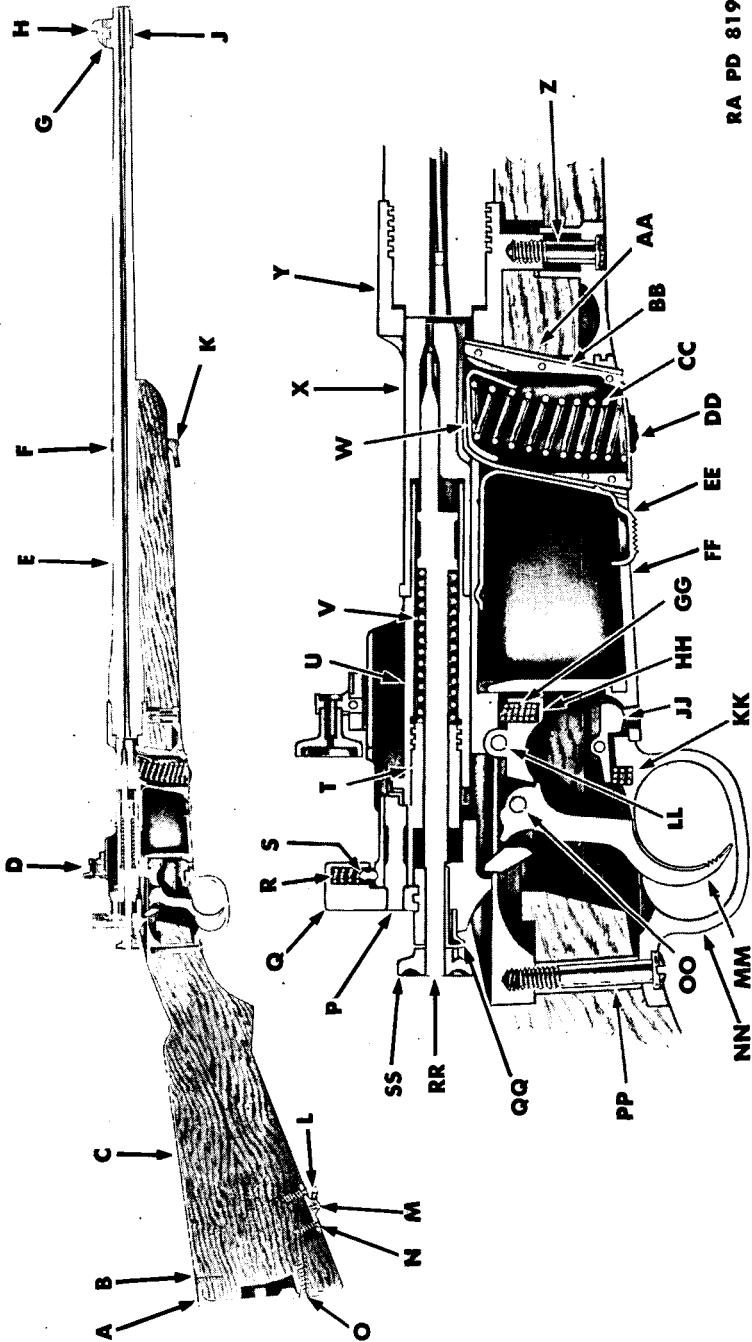

RA PD 81971

Figure 13 — U.S. Rifle, Cal. .22, M2 — Sectional View

DESCRIPTION AND FUNCTIONING

- | | | |
|--|-----------------------------|---------------------------|
| A —PLATE—C3831 | P —SPINDLE—A130028 | DD —BASE—B8562 |
| B —SCREW—B146873 | Q —PIECE—B128409 | EE —SPRING—D28315 |
| C —STOCK—D28225 | R —SPRING—B146885 | FF —PLATE—C4007 |
| D —LYMAN RECEIVER REAR SIGHT
NO. 48C | S —PLUNGER—A130012 | GG —SPRING—B146886 |
| E —BARREL—D1816 | T —SLEEVE—C45033 | HH —SEAR—B128416 |
| F —BAND—B8563 | U —HANDLE—D28222 | JJ —CATCH—A135890 |
| G —STUD—B128427 | V —MAINSRING—B147303 | KK —SPRING—B146883 |
| H —SIGHT—A130025 | W —FOLLOWER—B8565 | LL —PIN—A130009 |
| J —STUD—B128426 | X —HEAD—D28223 | MM —TRIGGER—C64032 |
| K —SWIVEL—88890 | Y —RECEIVER—D28224 | NN —GUARD—D28221 |
| L —SWIVEL—A130036 | Z —SCREW—B128413 | OO —PIN—A130010 |
| M —PLATE—B128410 | AA —{ SIDE—D28312 | PP —SCREW—B128414 |
| N —SCREW—B146873 | { SIDE—D28311 | QQ —SPRING—A13484 |
| O —SCREW—B128412 | BB —RIB—C46041 | RR —PIN—C3996 |
| | CC —SPRING—B147068 | SS —NUT—B8796 |

RA PD 81971A

Nomenclature for Figure 13 — U.S. Rifle, Cal. .22, M2 — Sectional View

CALIBER .22 RIFLES, ALL TYPES

Section II

U.S. RIFLES, CAL. .22, M1 AND M2

7. GENERAL.

a. The manual operation and mechanical functioning of the M1 and M2 Rifles (fig. 13) are identical and, with the exception of the bolt mechanism and magazine, both rifles are the same. Because of this fact, and because the M1 Bolt is no longer being manufactured, the M2 only is described with the points in which the M1 differs being explained where necessary.

8. BOLT WITH FIRING MECHANISM ASSEMBLY.

a. The bolt with firing mechanism assembly can be removed from the rifle as a unit (fig. 14). It includes the bolt head assembly, the bolt handle group, and the firing mechanism assembly (fig. 15). For convenience, the firing mechanism assembly is described as two groups: the bolt sleeve group, and the firing pin group.

NOTE: The bolt with firing mechanism assembly of the M1 (fig. 16) includes the bolt head assembly, the bolt handle assembly, and the firing mechanism assembly (fig. 17). However, these assemblies differ from like assemblies of the M2 as explained in the notes pertaining thereto.

b. The Bolt Head Assembly.

(1) The bolt head assembly consists of the bolt head, extractor, ejector, ejector retaining pin, and ejector spring.

(2) The front end of the bolt head has the firing pin hole through which the firing pin passes to strike the cartridge (fig. 18). The front end is also chambered to receive the cartridge rim. Extending back on the bottom of the bolt head are two magazine clearance grooves

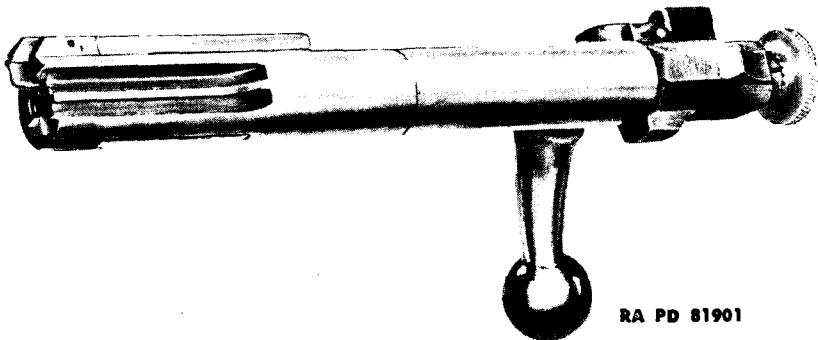

RA PD 81901

Figure 14 — Bolt With Firing Mechanism Assembly of
U.S. Rifle, Cal. .22, M2

DESCRIPTION AND FUNCTIONING

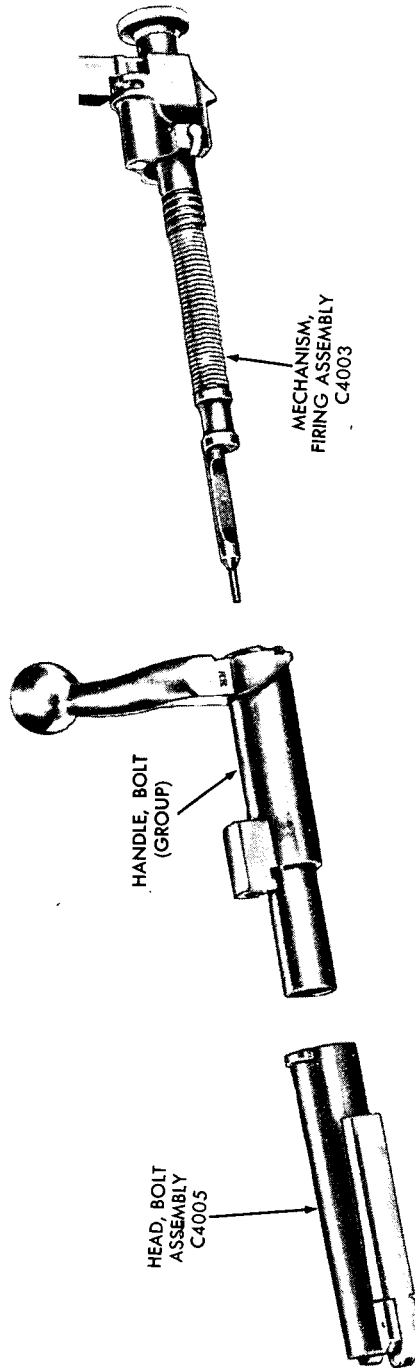
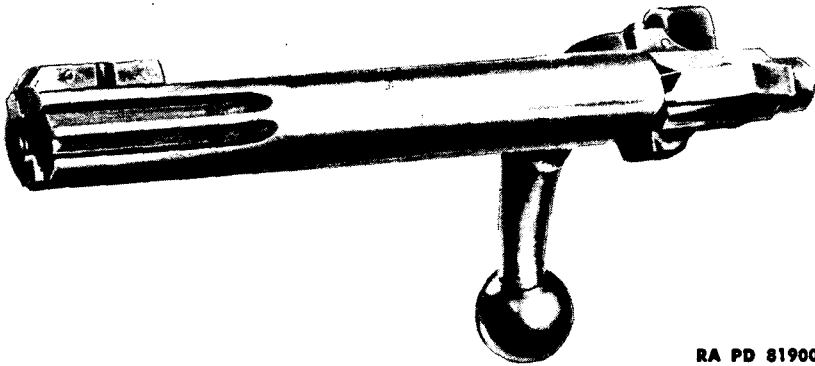

Figure 15 — Bolt Subassemblies of U.S. Rifle, Cal. .22, M2 — Exploded View

CALIBER .22 RIFLES, ALL TYPES



RA PD 81900

**Figure 16 – Bolt With Firing Mechanism Assembly of
U.S. Rifle, Cal. .22, M1**

which permit the bolt to clear the sides of the magazine tube. Between the grooves is a lug which serves to push the cartridge forward until it is out of the magazine and received by the chambered front of the bolt head. The bolt head is also slotted on the right side to provide a seat for the extractor.

(3) At the front end of the extractor, there is a hook by which the cartridge case is extracted from the chamber (fig. 19). The tongue just back of the hook rides in a groove in the extractor slot, and the undercut lug seats in an undercut hole in the extractor slot to hold the extractor in the bolt head.

(4) The back portion of the bolt head is bored out to receive the bolt handle and a smaller bore at the top continues to the front of the head to receive the firing pin. On the top back of the bolt head is a latch lug which engages the locking lug located on the bolt handle (fig. 20).

(5) The ejector is mounted by means of the ejector retaining pin on the left front side between two lugs which serve also as a guide for the bolt in the receiver. The ejector spring returns the ejector to position after the cartridge case has been ejected.

(6) The ejector is operated by the ejector stop group which includes a thumbpiece which is part of the body (fig. 21). The ejector stop is mounted in the left side of the receiver by a spindle and locked in place by a set screw passing through the thumbpiece of the ejector stop. On the back of the ejector stop is a plunger which rides in a groove in the receiver under pressure of the ejector stop spring to retain the ejector stop in either of its two positions. The inside of the ejector stop has a dismounting groove which matches the inside of the receiver, thus opening the passage way for the retraction of the bolt when the stop is turned to its horizontal position.

DESCRIPTION AND FUNCTIONING

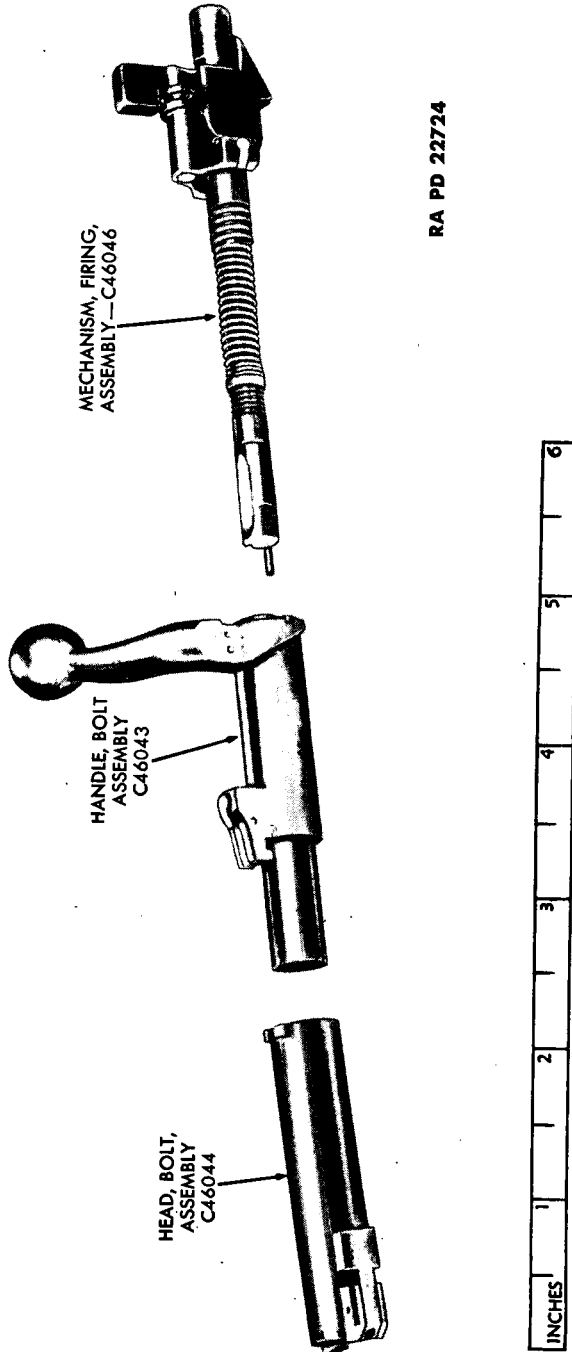

Figure 17 — Bolt Subassemblies of U.S. Rifle, Cal. .22, M1 — Exploded View

CALIBER .22 RIFLES, ALL TYPES

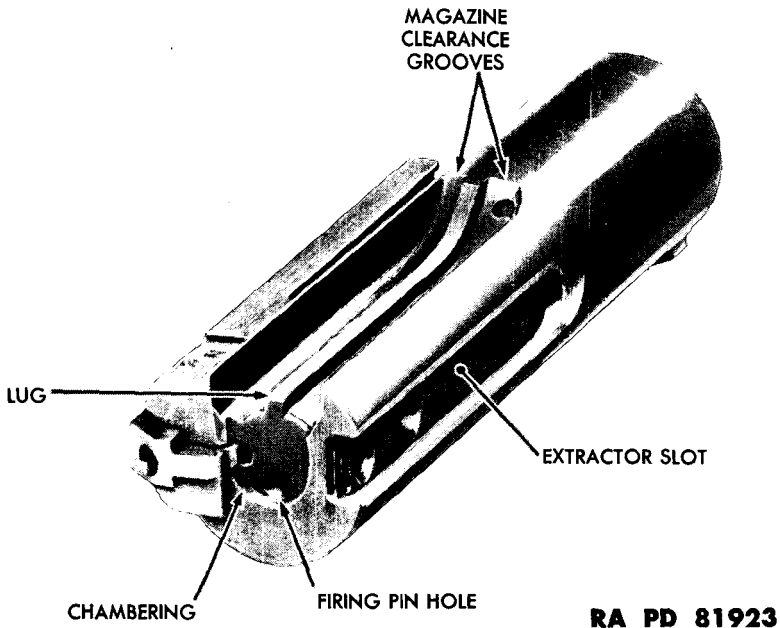

Figure 18 – Bolt Head Assembly, Extractor Removed, of U.S. Rifle, Cal. .22, M2

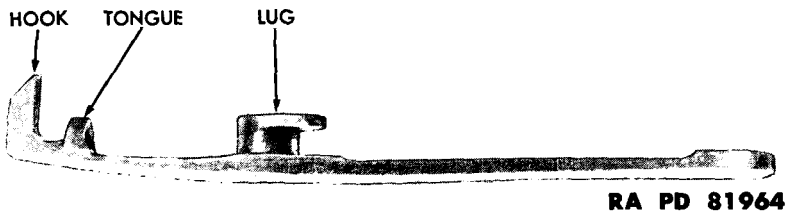

Figure 19 – Extractor of U.S. Rifle, Cal. .22, M2

NOTE: The bolt head assembly on the M1 is essentially the same as on the M2, but the ejector is not as long (fig. 22). The M1 Locking Lug is split into two twin lugs to receive the bolt head latch. The extractor is the same except for the dimensions and the contour of the hook, and should never be interchanged with the M2 Extractor.

c. Bolt Handle Group.

(1) The bolt handle group consists of the bolt handle, the head space adjusting screw, and the head space adjusting screw locking plug (fig. 23).

(2) The forward portion of the bolt handle sleeve is reduced in diameter to fit into the bolt head. A locking lug is formed on the outer surface of the sleeve of the bolt handle and extends slightly over the reduced portion. The lug sustains the shock of discharge by

DESCRIPTION AND FUNCTIONING

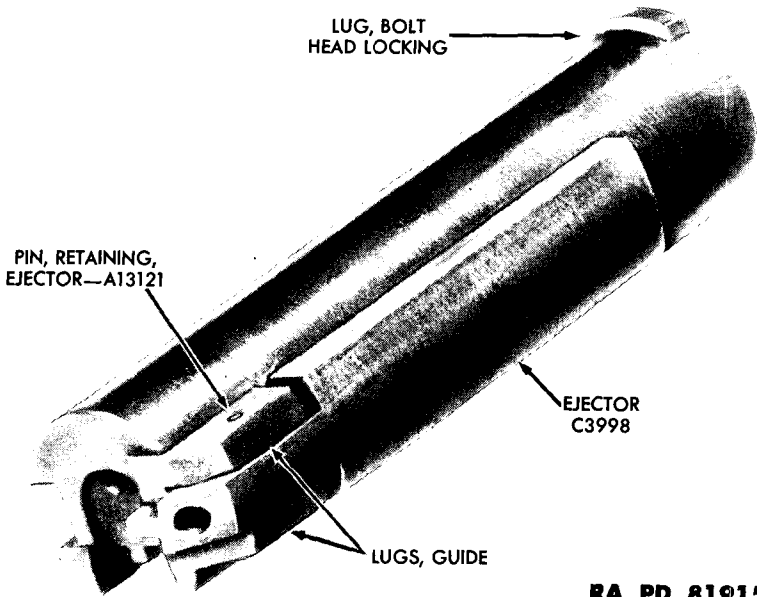

RA PD 81915

Figure 20 – Bolt Head Assembly of U.S. Rifle, Cal. .22, M2, Extractor Removed – Top Front View

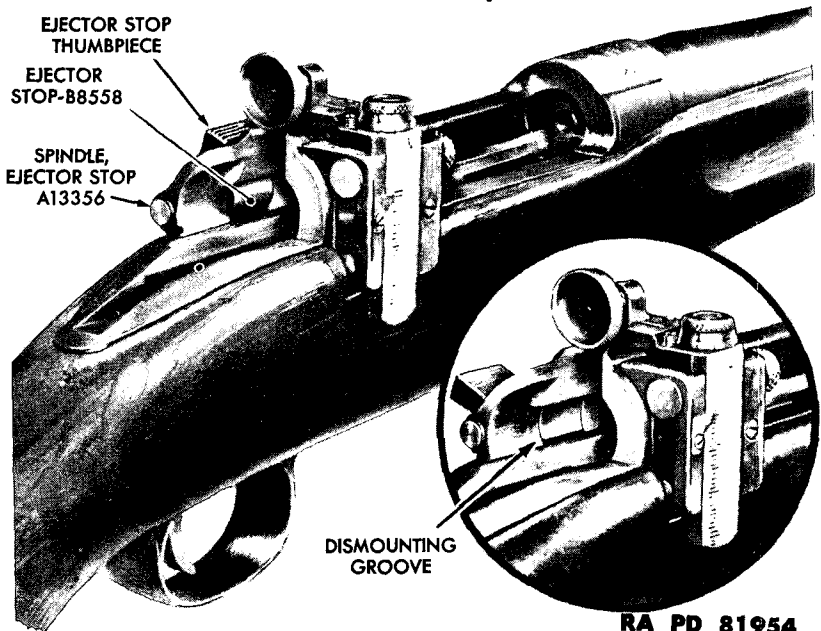

RA PD 81954

Figure 21 – Receiver Section Showing Ejector Stop on U.S. Rifle, Cal. .22, M2 – Locked and Unlocked Positions

CALIBER .22 RIFLES, ALL TYPES

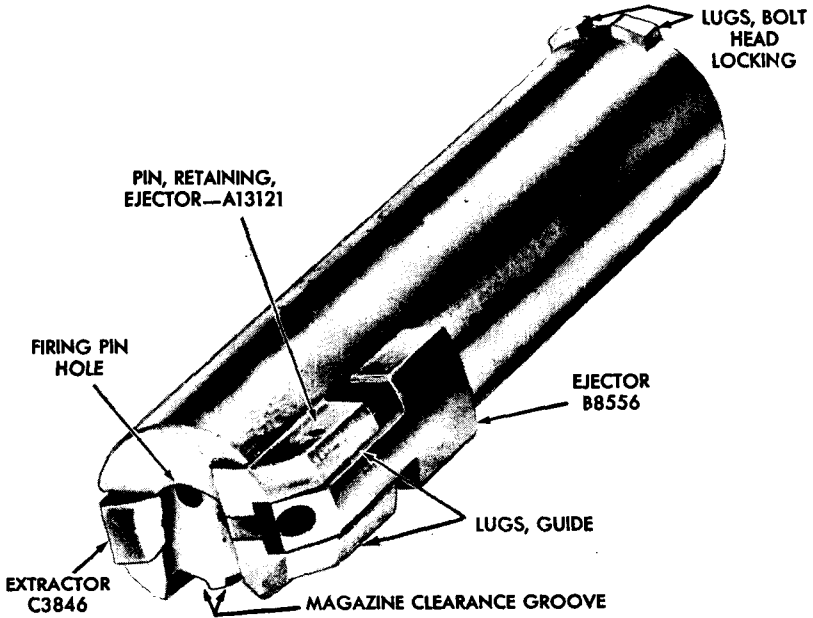

RA PD 81962

Figure 22 – Bolt Head Assembly of U.S. Rifle, Cal. .22, M1

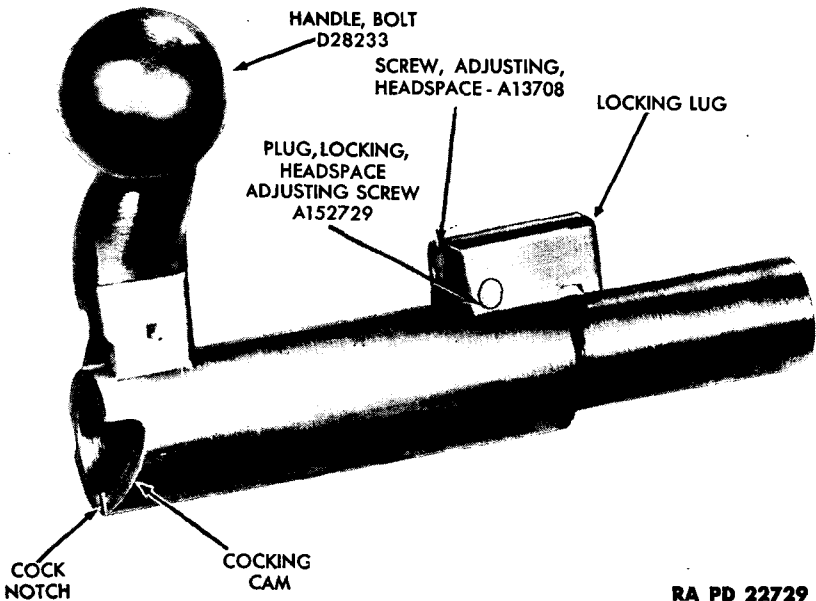

RA PD 22729

Figure 23 – Bolt Handle Group of U.S. Rifle, Cal. .22, M2 – Side View

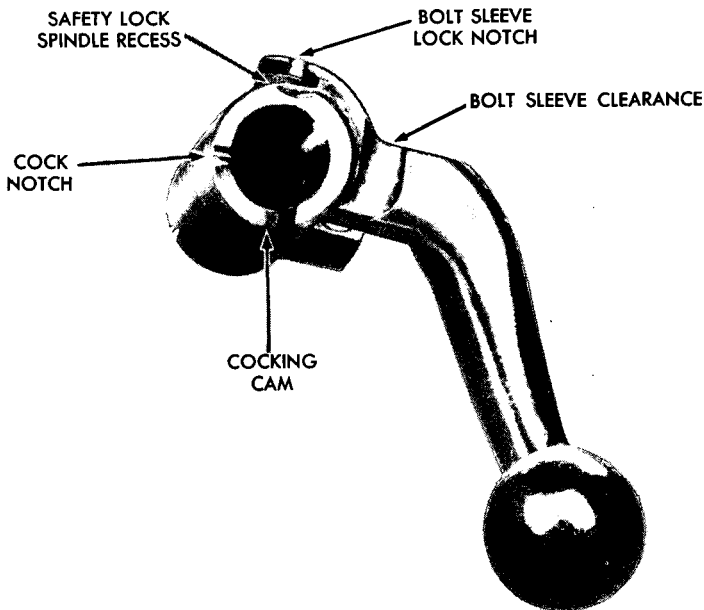
DESCRIPTION AND FUNCTIONING

RA PD 81948

**Figure 24 — Bolt Handle Group of U.S. Rifle, Cal. .22,
M2 — Back View**

engagement with the locking shoulders on the inside of the receiver. The lug is grooved on the under side permitting it to pass over the lug on the rear of the bolt head when the handle is lifted, thus locking the bolt head and handle. This is accomplished because the firing pin hole in the bolt head is off center so that the firing pin and bolt sleeve will not turn in the bolt head. Since the bolt handle is locked to the bolt sleeve when it is raised, it is also locked to the bolt head.

(3) A head space adjusting screw is located lengthwise in the lug. It is locked by a head space adjusting screw locking plug. No adjustment should be made except by qualified ordnance personnel. (On early types of M2 Rifles, the head space adjusting screw was adjusted with a screwdriver and was locked by a set screw in the side of the lug. The hole for the adjusting screw was then plugged to prevent accidental loosening and tampering by unauthorized personnel.)

(4) The back of the bolt handle (fig. 24) is recessed to provide clearance for the bolt sleeve and to act as a stop for the handle. The back end is also machined out to provide a recess for the front of the safety lock spindle when the safety lock is turned. Just above the safety lock spindle recess is the bolt sleeve lock notch in which the bolt sleeve lock seats to lock the sleeve to the handle.

(5) The bottom of the bolt handle is recessed to form the cocking

CALIBER .22 RIFLES, ALL TYPES

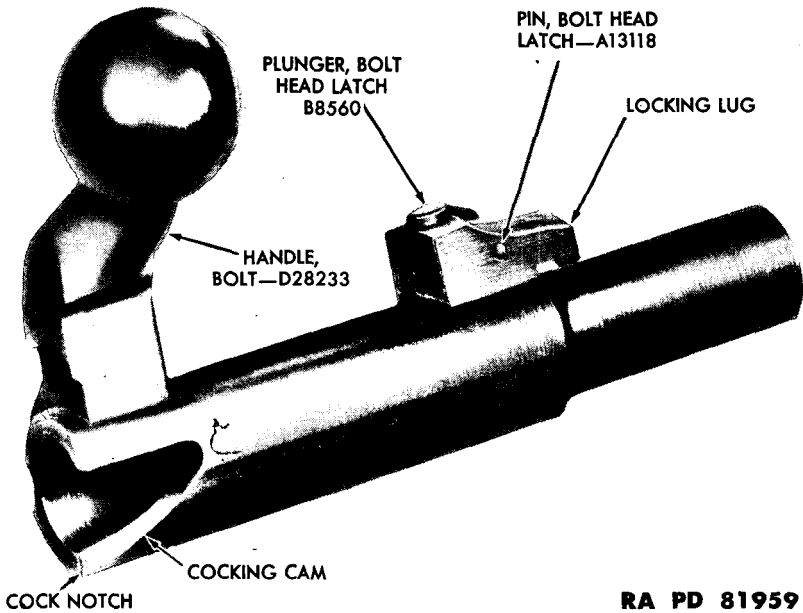

RA PD 81959

Figure 25 — Bolt Handle Assembly of U.S. Rifle, Cal. .22, M1 — Side View

cam in which the nose of the cocking piece is seated when the rifle is not cocked. The cam action forces the firing pin to the rear to cock the rifle when the handle is lifted. A cock notch is located just at the upper end of the cocking cam to receive the cocking piece nose when the rifle is cocked.

(6) The front of the handle proper is cut away to provide the extractor cam which engages the cam on the inner surface of the receiver to force the bolt assembly to the rear when the handle is raised.

(7) The interior of the bolt handle is threaded to receive the bolt sleeve.

NOTE: The M1 Bolt Handle Assembly is essentially the same as the M2 (fig. 25), except that the head space adjusting feature is missing and that the locking lug is replaced by a split locking lug in the center of which is located a bolt head latch, bolt head latch plunger, bolt head latch spring and bolt head latch pin. The latch, latch plunger, and latch spring are mounted in the split in the lug by means of the latch pin. The latch plunger projects above the top of the locking lug; when the bolt handle is raised, the plunger is depressed by contact with the receiver, thus depressing the plunger which pushes the back end of the latch down to raise the front end to allow it to pass over the first of the twin lugs on the bolt head and then seat

DESCRIPTION AND FUNCTIONING

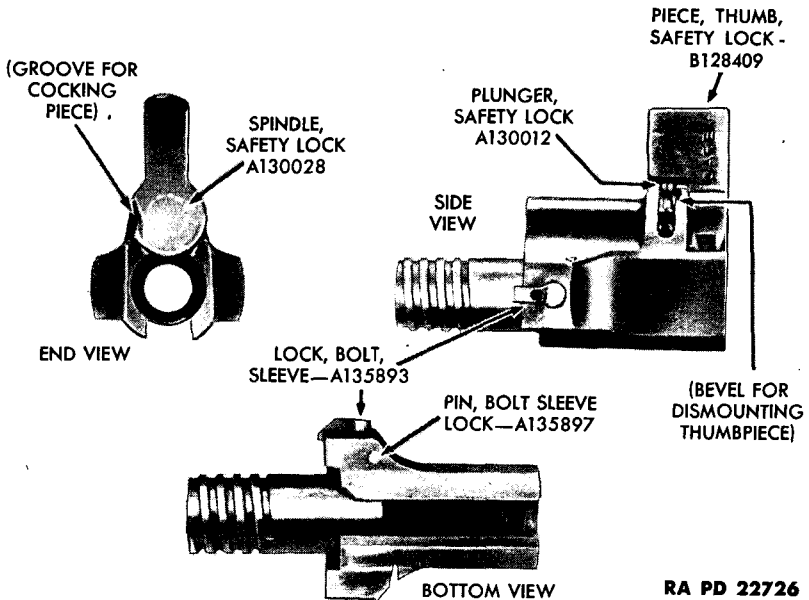

Figure 26 – Bolt Sleeve Group of U.S. Rifle, Cal. .22, M2

between them and lock the head and handle together as the latch spring returns both parts to position.

d. Bolt Sleeve Group.

(1) The bolt sleeve group consists of the bolt sleeve assembly and the safety lock assembly (fig. 26).

(2) The bolt sleeve assembly includes the bolt sleeve, the bolt sleeve lock, the bolt sleeve lock pin, and the bolt sleeve lock spring.

(3) The barrel of the bolt sleeve is threaded to secure the sleeve to the bolt handle. The front of the sleeve is cut away to permit seating over the bolt handle. A cocking piece slot at the bottom of the bolt sleeve provides an opening for the cocking piece.

(4) The bolt sleeve lock with its spring is mounted in a recess in the left side of the bolt sleeve. It locks the bolt sleeve to the bolt handle by entering its notch in the bolt handle. It is designed to prevent accidental turning of the sleeve when the bolt is drawn back.

(5) The safety lock spindle is seated in a hole drilled in the top of the bolt sleeve. There is a groove in the top of the bolt sleeve in which the plunger of the safety lock moves. Three detents are provided in the groove for the three positions of the safety lock. Extending back from the groove is a bevel for dismounting the safety lock from the bolt sleeve.

(6) The safety lock is a permanent assembly. It consists of a safety lock with thumbpiece for turning the safety lock, safety lock

CALIBER .22 RIFLES, ALL TYPES

spindle, the safety lock plunger, and the safety lock spring (fig. 26).

(7) The safety lock is mounted to the bolt sleeve by means of the safety lock spindle which extends through a hole in the top of the lock and the sleeve. When the safety lock is in the safe position, the bolt handle is prevented from rotating by contact with the front of the safety lock spindle. The bolt handle clearance on the front of the safety lock spindle permits the bolt handle to clear the spindle in the ready and neutral positions.

(8) The safety lock plunger, assembled in the thumbpiece, projects into its groove in the bolt sleeve under pressure of the plunger spring and prevents any movement of the lock to the rear.

(9) Two cams on the bottom of the thumbpiece form a locking groove between them. When the safety lock is moved from "ready" position to either "neutral" or "safe," the cams pass on each side of the locking shoulder of the cocking piece, thus permitting the locking groove of the safety lock to seat over the locking shoulder of the cocking piece and preventing it from moving when the trigger is pulled. A cocking piece groove on the thumbpiece permits the cocking piece to move when the safety lock is in the "ready" position.

e. Firing Pin Group.

(1) The firing pin group consists of the cocking piece, locking spring, firing pin, firing pin nut, and main spring (fig. 27).

(2) The front of the firing pin is a striker. Back of the striker is a shoulder against which the main spring seats. The rear end of the firing pin rod is reduced in diameter to take the cocking piece and is threaded to receive the firing pin nut and locking spring. The inside of the nut is serrated to lock against the locking spring located in a notch in the back end of the cocking piece. This prevents the firing pin nut from being jarred loose by the vibration of discharge.

(3) The cocking piece has two grooves cut in its top to form a locking shoulder between them over which the cocking piece groove of the safety lock slides (subpar. d (6), above). The nose of the cocking piece rests against the lower edge of the cocking cam of the bolt handle when the gun is uncocked. When the gun is being cocked, the cocking cam of the cocking piece moves upward in the cocking cam of the bolt handle until it seats in the cock notch of the bolt handle which prevents it from accidentally returning to the uncocked position. At the bottom of the cocking piece is a sear notch which engages the sear nose when the gun is being cocked, thus keeping the cocking piece and the firing pin stationary while the bolt moves forward when the handle is returned to the closed position.

NOTE: The firing mechanism assembly of the M1 Rifle is different from the M2. The striker assembly consists of the firing pin head and the striker (fig. 28). These are permanently assembled during manufacture. The firing pin head is slotted to provide a clear-

DESCRIPTION AND FUNCTIONING

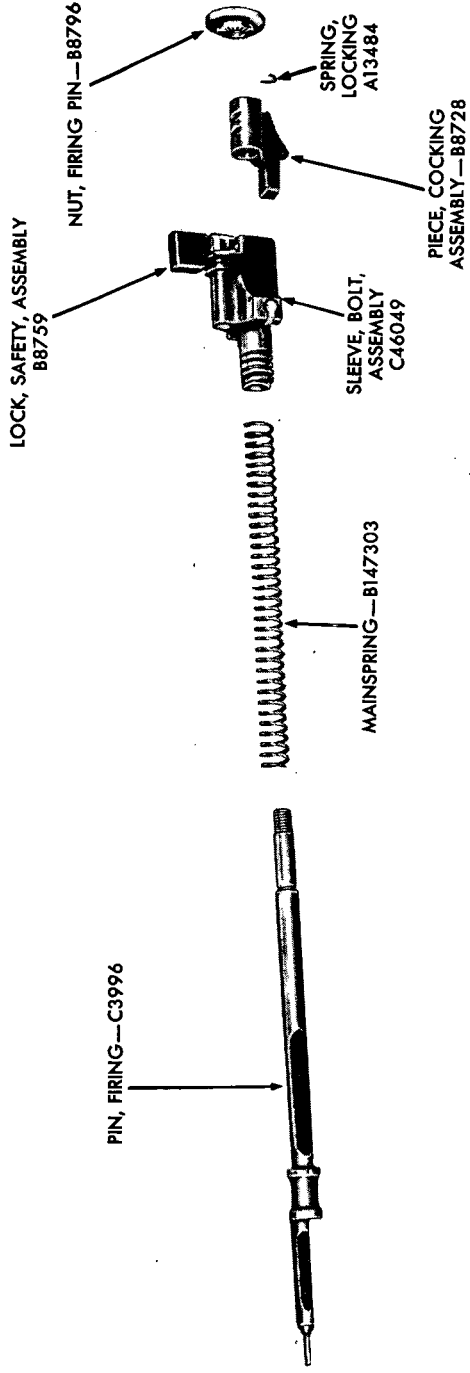

RA PD 81953



Figure 27 — Firing Mechanism Assembly of U.S. Rifle, Cal. .22, M2 — Exploded View

CALIBER .22 RIFLES, ALL TYPES

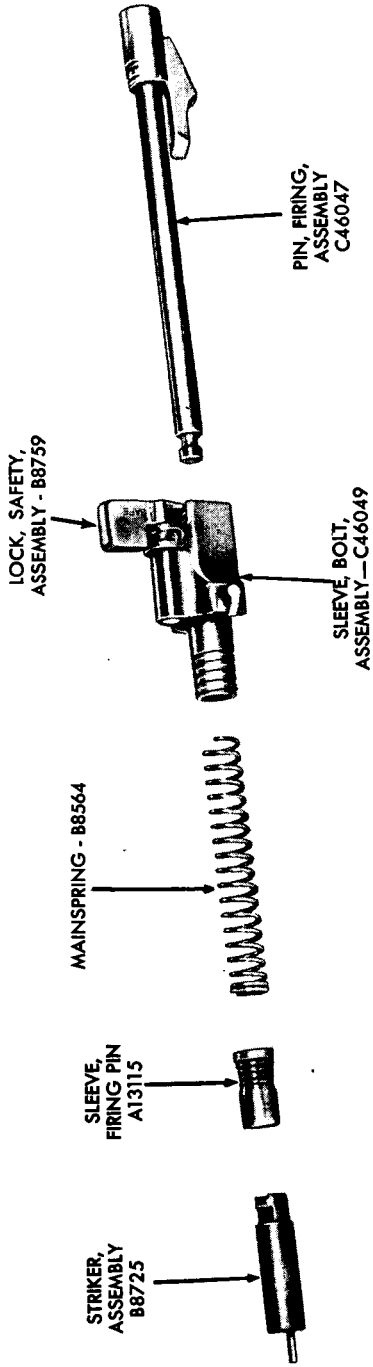

RA PD 22728

Figure 28 — Firing Mechanism Assembly of U.S. Rifle, Cal. .22, M1 — Exploded View

DESCRIPTION AND FUNCTIONING

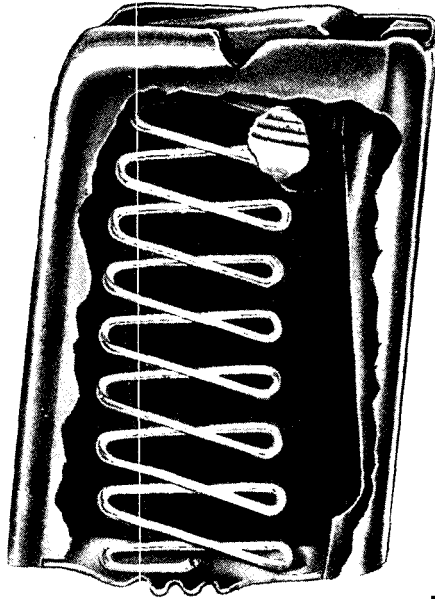

RA PD 81837

Figure 29 – Magazine Assembly of U.S. Rifle, Cal. .22, M2 -- Cutaway View

ance for the ejector. The striker assembly is secured to the firing pin rod by means of a joint hole. The firing pin sleeve fits over the rear end of the firing pin head and the front end of the firing pin rod covering the joint hole and preventing accidental separation of the firing pin head and firing pin rod. Its rear end forms the front bearing for the mainspring while the back end of the mainspring seats against the bolt sleeve. The firing pin assembly consists of the firing pin rod and the cocking piece. The rod is screwed to the cocking piece and riveted over in assembly. The front of the firing pin rod consists of a neck and head which fit over the joint hole of the striker, being held in place by the action of the mainspring against the firing pin sleeve which slides over the end of the striker. The cocking piece has two locking grooves cut in its top to form a locking shoulder over which the cocking piece groove of the safety lock slides.

9. MAGAZINE ASSEMBLY.

a. The magazines of the M2 and the M1 Rifles appear the same but are not interchangeable and *must* be used with their corresponding bolts. Complete units of both bolt and magazine must be used together. The magazine is inserted through the floor plate and is retained in place by the magazine retaining spring which seats in the bottom of the receiver against the magazine (par. 11 b).

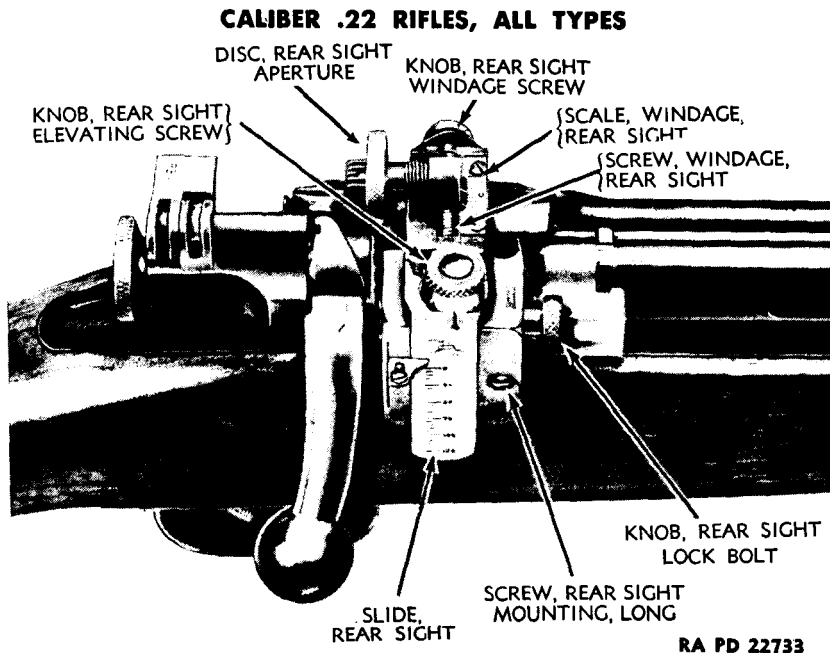

**Figure 30 – Rear Sight Assembly Mounted on U.S. Rifle,
Cal. .22, M2 – Right Top View**

b. The magazine assembly includes the magazine tube, the magazine base, magazine spring, and magazine follower (fig. 29).

c. The magazine tube is a permanent assembly and no attempt should ever be made to take it apart.

d. A serrated thumbpiece on the follower extends through a slot in the side of the magazine tube and is used to compress the magazine spring when loading the magazine.

e. The magazine base fits in two slots in the bottom of the tube.

f. The magazine spring maintains a pressure on the magazine follower, forcing the cartridge to the top of the magazine where lips on the tube retain it until it is moved forward to a point where a slot in each lip permits the cartridge rim to enter and the cartridge to leave the magazine.

10. REAR SIGHT GROUP.

a. A Lyman No. 48C sight (assembly) is mounted on the receiver bridge (fig. 30) by means of two mounting screws, one long and one short. The short screw is located under the elevating slide.

b. The rear sight base is slotted to take the elevating slide, and drilled longitudinally at the top for the rear sight lock bolt (fig. 31). The bolt and base are grooved in the center to take the rear sight

DESCRIPTION AND FUNCTIONING

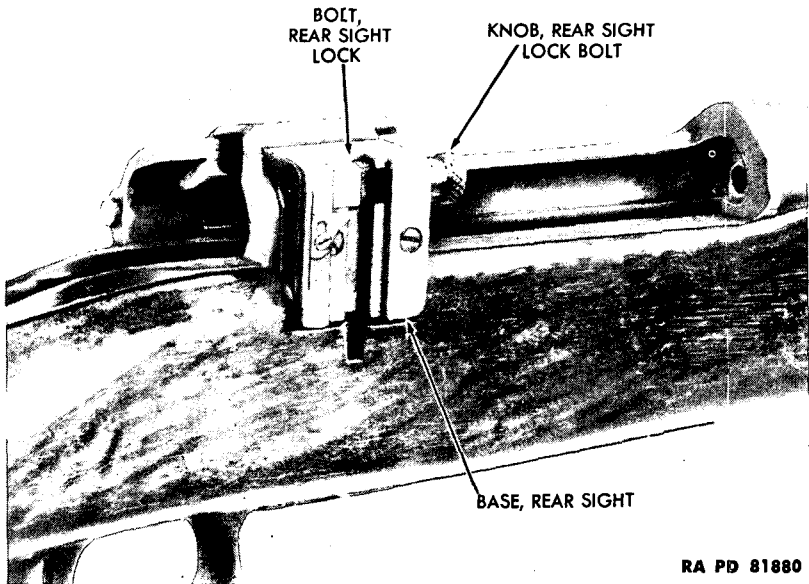

RA PD 81880

Figure 31 – Rear Sight Base Mounted on U.S. Rifle, Cal. .22, M2

elevating screw. The bolt is slotted at the left end to hold the flat rear sight lock bolt spring which is attached at the bottom of the base with a screw. The left side of the grooved portion of the bolt is threaded to correspond with the threads of the elevating screw. These threads are held in tension against the elevating screw by the spring permitting the elevating screw to be turned up or down in the threads. The rear sight lock bolt knob screws on the right side of the rear sight lock bolt and is held by the rear sight lock bolt knob set screw. This permits the rear sight lock bolt knob to be unscrewed part way when

CALIBER .22 RIFLES, ALL TYPES

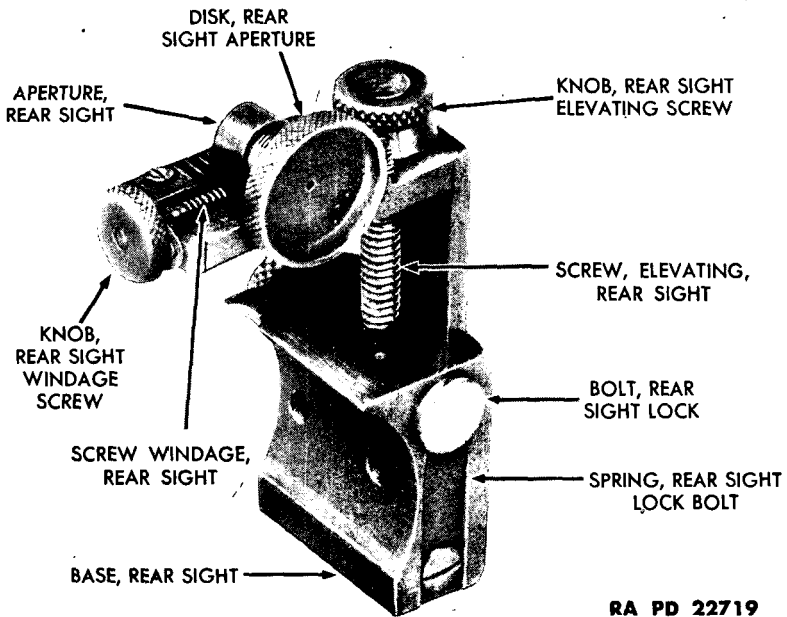

RA PD 22719

Figure 32 – Rear Sight Assembly of U.S. Rifle, Cal. .22, M2 – Left Rear View

elevating slide directly in front of the aperture. The screw holes of the windage scale are elongated to provide for adjustment.

11. BARREL AND RECEIVER GROUP.

a. The barrel and receiver assembly, composed of the barrel assembly and receiver, of the M2 and M1 Rifles are identical with the exception of the identification markings on the upper front surface of the receiver. The barrel and receiver assembly are a permanent assembly and are not to be separated. The barrel and receiver group is composed of the barrel and receiver assembly, the front sight group, the trigger mechanism group, and the magazine retaining spring (fig. 33).

b. Barrel Assembly.

(1) The barrel assembly consists of the barrel, fixed stud, and the fixed stud pin. The barrel is 24 inches long and the rifling consists of four plain grooves 0.0025 inch deep. The twist is uniform right hand, one turn in 16 inches. The muzzle is rounded to protect the rifling, and the tenon at the rear is threaded for the purpose of securing the receiver to the barrel. The breech of the barrel is recessed to receive the ends of the ejector and extractor. On the top in the rear of the fixed stud are stamped the ordnance escutcheon, the initials of the place of manufacture, and the month year of manu-

DESCRIPTION AND FUNCTIONING

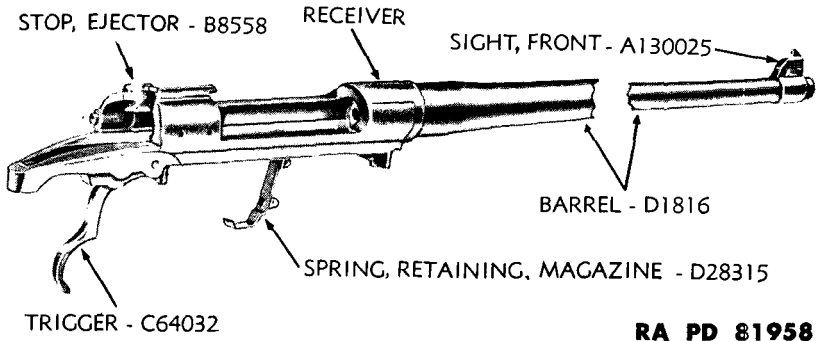

Figure 33 – Barrel and Receiver Group of U.S. Rifle, Cal. .22, M2

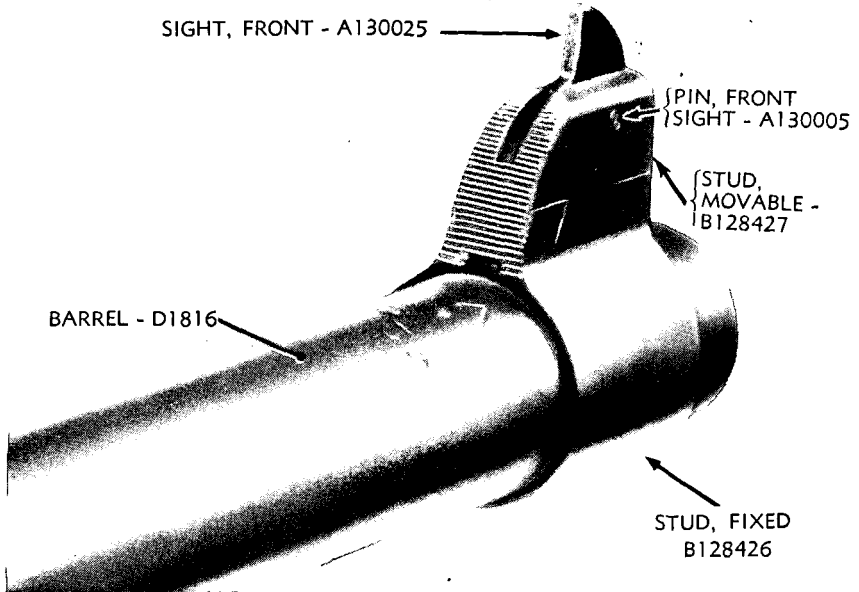
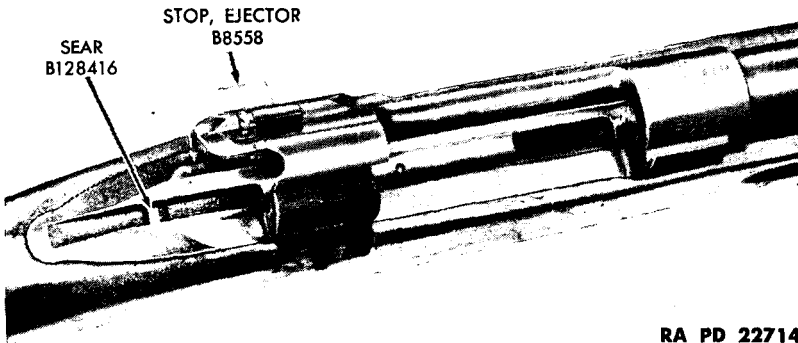

Figure 34 – Front Sight Group of U.S. Rifle, Cal. .22, M2

facture. On the upper left hand side, directly in front of the tenon threads is stamped "Long rifle Cart'ge only."

(2) The fixed stud, to which is assembled the front sight group, is prevented frm moving laterally by a slot which bears on a lug on the upper side of the barrel. The fixed stud pin enters a hole in the fixed stud and a slight recess on the top of the barrel, preventing longitudinal displacement of the stud.

CALIBER .22 RIFLES, ALL TYPES



RA PD 22714

**Figure 35 — Receiver Section of U.S. Rifle, Cal. .22,
M2 — Bolt Removed — Top View**

c. **Front Sight Group.** The moveable stud of the front sight group (fig. 34) fits into the undercut slot in the fixed stud. The front sight fits in a slot in the moveable stud and is held in place with a tapered pin both ends of which are upset to prevent accidental removal. The rear face of both the fixed stud and the moveable stud are serrated on the back to prevent any reflection of light from the surface interfering with the aiming of the rifle.

d. **Receiver.** The receiver (fig. 35) is machined to receive the bolt and is open at the forward portion for the ejection of cartridge cases. The rear portion is bridged; the front surface of the bridge forming a locking shoulder and cam for the locking lug on the bolt handle (par. 8 c). Two tapped holes in the bridge of the receiver serve as a mounting for the rear sight assembly. A cam on the rear inside of the bridge of the receiver acts to start the initial backward and final forward movement of the bolt (par. 13). A rectangular groove extends the full length of the receiver on the left side. This groove serves as a guideway for the ejector lugs, and prevents rotation of the bolt head. An extension to the rear of the receiver is tapped for the rear guard screw. The front end of the receiver, which seats in the stock, is tapped for the front guard screw. An oblong hole is provided in the bottom of the receiver for the magazine. Another slot is provided for the sear. The ejector stop is mounted in a slot in the left back of the receiver.

e. **Trigger Mechanism Group.** The trigger mechanism (fig. 36) includes the sear, sear pin, trigger, and trigger pin. The sear is pivoted on a pin between the lugs on the receiver and the trigger pivots in a slot in the sear. The sear spring is seated in a seat in the forward end of the sear and bears against the receiver bottom. The

DESCRIPTION AND FUNCTIONING

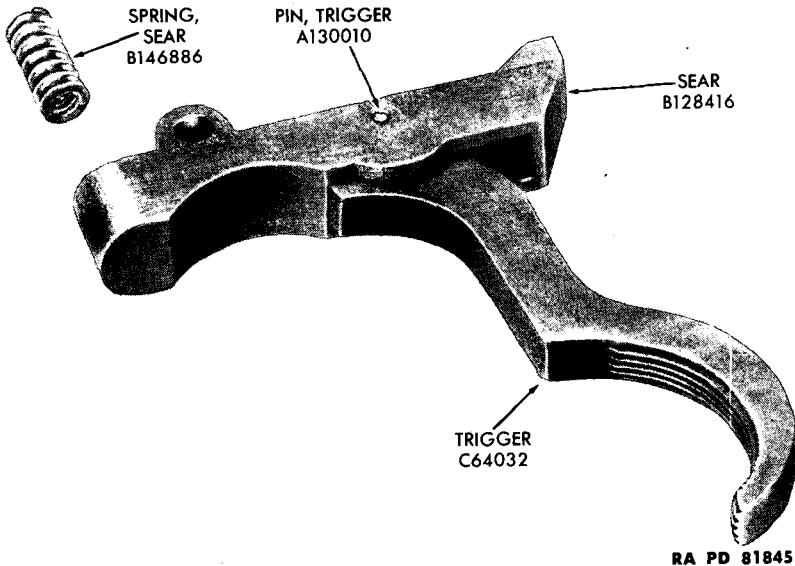

RA PD 81845

Figure 36 – Sear and Trigger Group of U.S. Rifle, Cal. .22, M2

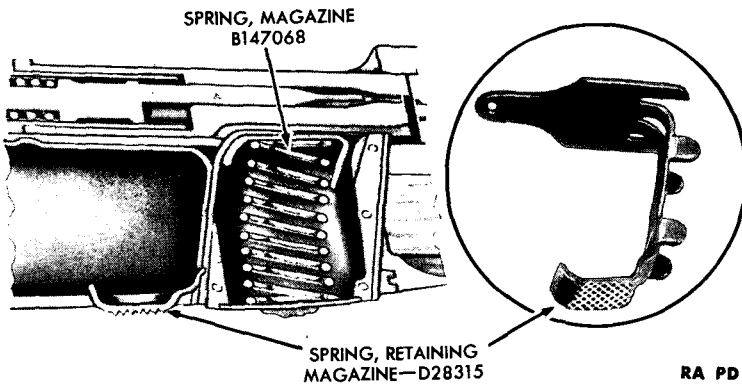

RA PD 81944

Figure 37 – Magazine Retaining Spring of U.S. Rifle, Cal. .22, M2 – Showing Position When Assembled

sear nose extends through the bottom of the receiver in the path of the sear notch of the cocking piece.

f. Magazine Retaining Spring. The magazine retaining spring is formed with a flat base which fits into grooves in the receiver (fig. 37). A detent on the end of the base engages a depression in the receiver and retains it in position. Lugs on the sides of the spring act as guides for the magazine and a shoulder is provided for engage-

CALIBER .22 RIFLES, ALL TYPES

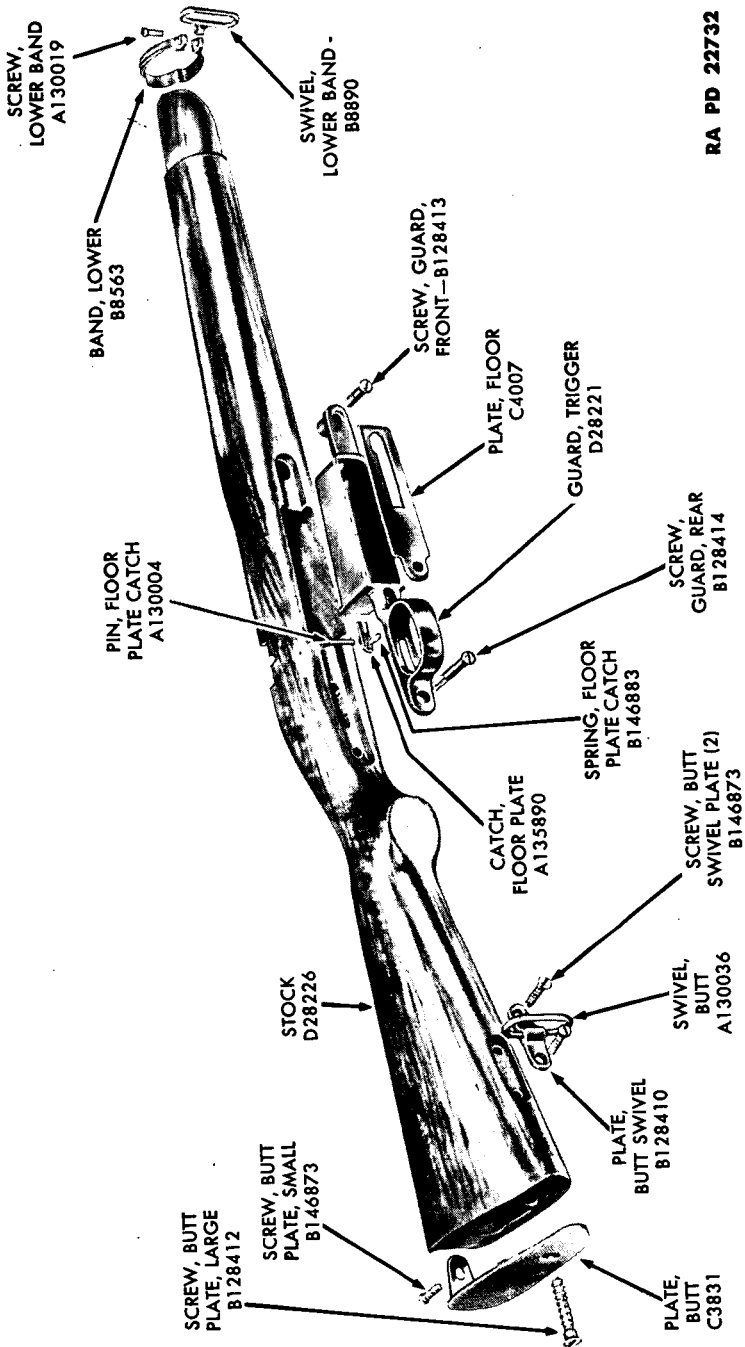

RA PD 22732

Figure 38 — Stock Group of U.S. Rifle, Cal. .22, M2 — Exploded View

DESCRIPTION AND FUNCTIONING

ment with the retaining recess in the magazine. The lower end of the retaining spring is bent backward. The outer surface is serrated and extends slightly beyond the floor plate. Pressure on this serrated portion of the spring releases the magazine.

12. STOCK GROUP.

a. The stock group includes the stock assembly, butt plate, floor plate, trigger guard group, lower band, lower band swivel, and butt swivel assembly (fig. 38).

b. The stock is cut out at the top for the barrel, receiver, and rear sight. A shoulder is cut near the forward end as a seat for the lower band, and the two projecting ends of a pin set in the stock hold the band in position. Grasping grooves are cut in the front sides of the stock. The top of the butt plate seat is mortised into the back of the butt. The bed of the stock is mortised to receive the magazine, floor plate, trigger-sear, and trigger guard groups.

c. The guard screw bushing fits tightly in a hole in the stock between the receiver and the rear tang of the trigger guard and serves to prevent the stock from being crushed when the guard screw is tightened.

d. The butt plate is attached to the rear of the stock by two screws.

e. The butt swivel assembly includes the butt swivel plate, the butt swivel, and the butt swivel pin. The butt swivel pin retains the butt swivel in place in the plate and two screws retain the butt swivel plate to the stock.

f. The floor plate fits into its mortise in the bottom of the stock (fig. 38). The tenon of the floor plate fits into a groove at the front end of the trigger guard and with the assistance of the floor plate catch retains the floor plate securely in its place at the bottom of the trigger guard. The lug of the floor plate is slotted to receive the floor plate catch, and the lug has a tenon on its front end which fits into a slot in the trigger guard. Directly in back of the lug is a hole through which the floor plate catch projects. The magazine spring and magazine project through openings provided in the floor plate.

g. The trigger guard is set flush in the bottom of the stock and is secured in place by the two guard screws engaging drilled and threaded lugs in the receiver.

h. The floor plate catch is secured to the trigger guard by means of the floor plate catch pin. A floor plate catch spring, under the catch, maintains a tension on the catch for the retention of the floor plate.

i. The lower band is formed to the contours of the stock and barrel and is positioned on the stock against the shoulder provided for it. The front or upper end of the lower band is designated by the stamped letter "U," which must be assembled with the open end

CALIBER .22 RIFLES, ALL TYPES

facing the muzzle. The band is split at the bottom, the ends being formed into ears which are machined and threaded for the lower band screw. The swivel fits between the ears of the band.

13. FUNCTIONING.

a. When the bolt handle is raised, the bolt head is kept from rotating by its engagement with the ejector slot in the receiver, and the bolt sleeve is kept from turning by the cocking piece which seats in its slot in the sleeve and a slot in the receiver.

b. The rotation of the handle engages the locking lug with the lug on the bolt head, and causes the cocking cam on the rear of the handle to force the cocking piece backward until the cocking piece nose seats in its cock notch on the handle. The rearward movement of the cocking piece also retracts the firing pin to which it is attached, thus compressing the mainspring.

c. During the latter part of the handle movement, the sleeve lock enters its notch in the bolt handle and the extraction cam on the bolt handle engages a cam on the inner surface of the receiver, forcing the bolt head, handle, and sleeve to the rear for about one-eighth of an inch. This action brings the bolt back far enough so that the bolt sleeve latch plunger is released, allowing the lock to lock the bolt handle and sleeve together. At the same time, the discharged cartridge case is loosened from the chamber. The lift of the handle is stopped by contact with the receiver.

NOTE: On the M1, the bolt head latch plunger is depressed as it hits the bridge of the receiver when the handle is raised. This action lowers the back end of the bolt head latch and raises the front end permitting it to pass over the right-hand lug of the bolt head. When the bolt is retracted and the bolt head latch passes out from the rear of the receiver bridge, the latch spring returns the plunger and latch to position, thus seating the latch between the two twin lugs on the bolt head and locking the bolt head and handle together.

d. As the bolt is retracted, it carries the discharged cartridge case back with it, since the rim of the case is held by the hook of the extractor. Near the limit of retraction, the ejector strikes the ejector stop. As the bolt continues its rearward movement, the ejector is held stationary, so pushing the cartridge case out from under the hook of the extractor and ejecting it from the rifle to the right. The engagement of the ejector with the ejector stop prevents full withdrawal of the bolt from the receiver. The bolt handle is prevented from turning by the eccentric bearing of the firing pin in the bolt head.

e. As the bolt uncovers the magazine on its retraction, the magazine spring and follower raises a cartridge partially out of the magazine until the rim is retained between the lips formed on the walls and the cartridge is held in an inclined position with the bullet extending

DESCRIPTION AND FUNCTIONING

up and out of the magazine. When the bolt is pushed forward, the lug on the bottom of the bolt head pushes the cartridge forward until the rim is released at the end of the magazine lips and forced up under pressure of the magazine spring into the recess in the bolt head face and under the extractor. Further closing of the bolt pushes the cartridge into the firing chamber of the barrel.

f. As the bolt sleeve contacts the back of the receiver, the bolt sleeve lock plunger is depressed, thus unlocking the bolt sleeve from the handle and permitting the handle to be turned down. At the same time, the lug of the cocking piece engages the sear in the bottom of the receiver holding the sear and firing pin stationary. As the handle is turned downward, the bolt assembly continues its forward movement as the cam on the locking lug bears against the locking shoulder in the receiver. The rifle is now cocked and ready to fire.

NOTE: On the M1 Rifle, as the bolt head latch passes the rear of the receiver bridge, the latch plunger is depressed. This action lowers the back end of the bolt head latch and raises the front end unlocking the bolt handle from the bolt head, thus permitting the handle to be turned down.

g. As the finger piece of the trigger is drawn to the rear, its contact with the receiver is transferred from the normal bearing surface on the trigger to the trigger heel, which gives a creep to the trigger. On this preliminary pull, the trigger pivots on its pin, the bearing engaging the receiver and partially rotating the sear around its pin, slightly depressing the sear nose. The contact of the heel completes the preliminary pull. Further pressure on the trigger releases the sear nose from the cocking piece and the firing pin is driven forward by the mainspring to strike the cartridge.

NOTE: In firing, unless the bolt handle is turned fully down, the cam on the cocking piece will strike the cocking cam on the bolt, and the energy of the mainspring will be expended in closing the bolt instead of on the cartridge head. This prevents the firing of a cartridge before the bolt is closed.

Section III

REMINGTON RIFLE, CAL. .22, MODEL 513T

14. GENERAL.

a. The Remington Rifle, cal. .22, Model 513T (fig. 39), differs from the U.S. rifles in its detailed construction of parts although it is basically the same in mechanical operation and functioning.

CALIBER .22 RIFLES, ALL TYPES

RA PD 81972

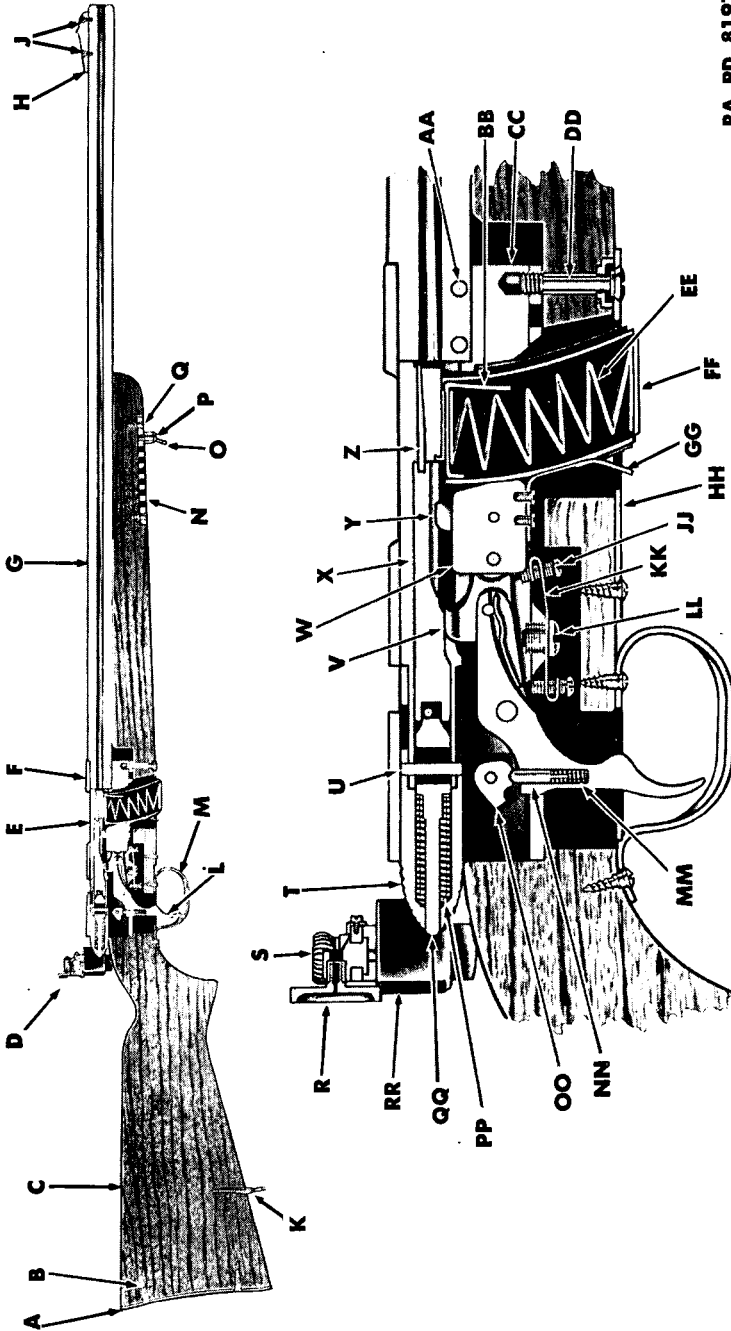

Figure 39 — Remington Rifle, Cal. .22, Model 513T — Sectional View

DESCRIPTION AND FUNCTIONING

A —PLATE—308	P —SCREW—113	DD —SCREW—393
B —SCREW—9	Q —SCREW—233	EE —SPRING—355
C —STOCK—235	R —DISC—564	FF —MAGAZINE—101-1/2
D —SIGHT—115	S —KNOB—565	GG —LOCK—107
E —BOLT—303	T —SLEEVE—6	HH —PLATE—2105
F —RECEIVER—371	U —PIN—7	JJ —SCREW—493
G —BARREL—230	V —SEAR—83	KK —SPRING—491
H —RAMP—503	W —INSERT—76	LL —SCREW—492
J —SCREW—504	X —PIN—40	MM —SPRING—500
K —SWIVEL—116	Y —EJECTOR—330	NN —PLUNGER—438
L —TRIGGER—29	Z —POINT—42	OO —SAFETY—499
M —GUARD—229	AA —PIN—2	PP —SPRING—59
N —BASE—232	BB —FOLLOWER—350	QQ —INDICATOR—128
O —SWIVEL—112	CC —INSERT—75	RR —BASE—584

RA PD 81972B

Nomenclature for Figure 39 — Remington Rifle, Cal. .22, Model 513T — Sectional View

CALIBER .22 RIFLES, ALL TYPES

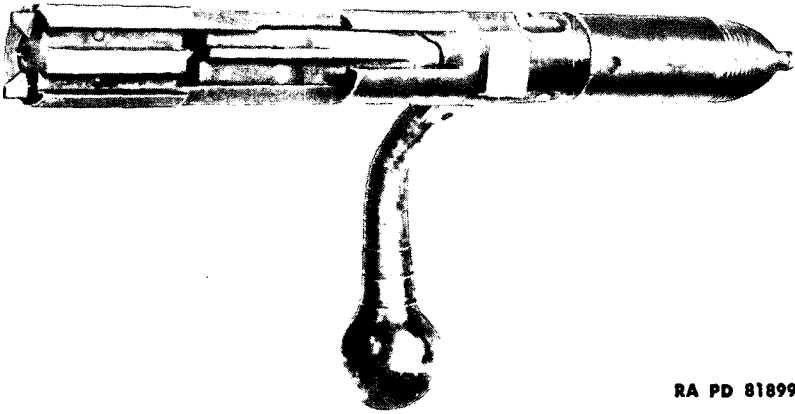

RA PD 81899

Figure 40 – Bolt Group of Remingotn Rifle, Cal. .22, Model 513T

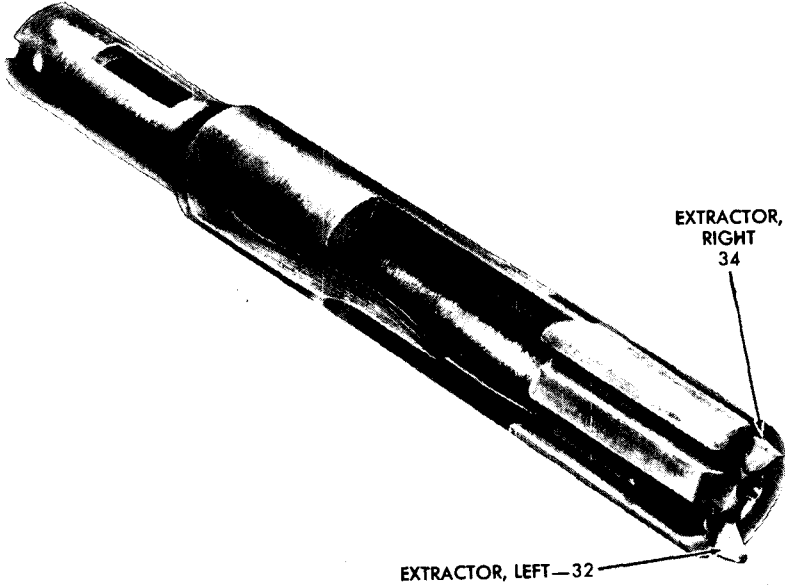

RA PD 81879

Figure 41 – Bolt With Extractors Assembled of Remington Rifle, Cal. .22, Model 513T

15. BOLT GROUP.

a. **General.** The bolt group is a semipermanent assembly and its disassembly should not be undertaken in the field. It is removed from the rifle as a unit (fig. 40). It includes the bolt with extractors, the bolt handle assembly, the bolt sleeve and pin, and the firing pin

DESCRIPTION AND FUNCTIONING

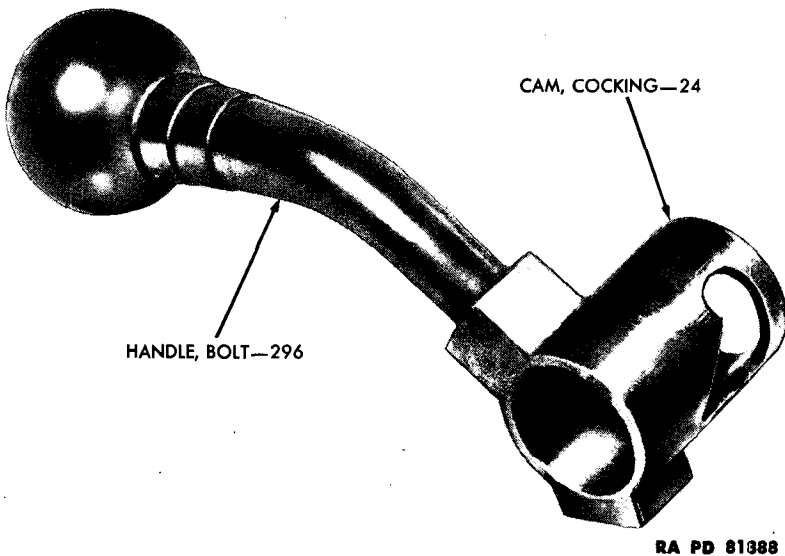

RA PD 81388

**Figure 42 — Bolt Handle Assembly of Remington Rifle,
Cal. .22, Model 513T**

group composed of the firing pin assembly, mainspring plunger, safety indicator, mainspring, and firing pin cam pin.

b. Bolt.

(1) The bolt has two slots machined in the front, where the two extractors are installed (fig. 41). The two extractors are retained in position by pins. The rear end of each extractor rests upon opposite ends of a spring extending through the bolt, the tension of which keeps the head of the extractors against the bottom of their slots.

(2) On the under side of the bolt are cut the magazine clearance grooves which are provided so that the bolt will clear the sides of the magazine tube. The lug in the center of the magazine clearance grooves acts to remove the cartridge from the magazine.

(3) The sear slot on the under side of the bolt provides a means for the sear of the trigger mechanism to engage in the sear slot of the firing pin when the bolt handle is raised and the rifle thus cocked.

(4) The front end of the bolt has the firing pin hole and is chambered to receive the base of the cartridge. The bolt is bored to receive the firing pin and the rear portion is undercut to receive the bolt handle assembly and the bolt sleeve. In the undercut portion is a slot provided for the firing pin cam pin.

c. Bolt Handle Assembly. The bolt handle is permanently fastened to the cocking cam during manufacture (fig. 42). The cocking cam is provided with two cams which act against the firing pin cam

CALIBER .22 RIFLES, ALL TYPES

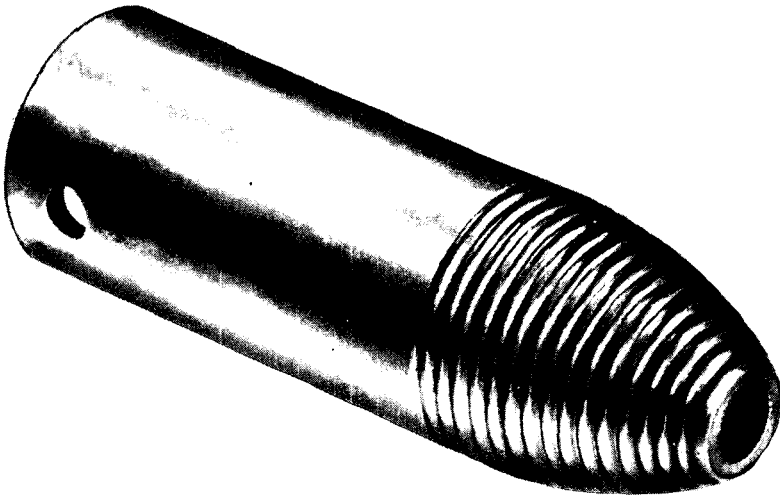

RA PD 81920

Figure 43 – Bolt Sleeve of Remington Rifle, Cal. .22, Model 513T

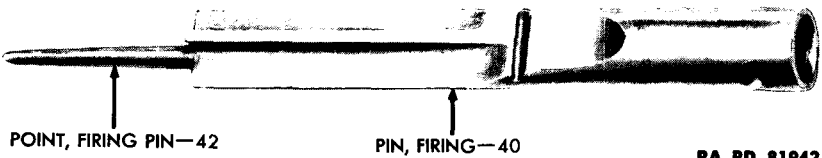

RA PD 81942

Figure 44 – Firing Pin Assembly of Remington Rifle, Cal. .22, Model 513T

pin to force the firing pin to the rear and cock the rifle when the bolt handle is raised. A lug formed on the top of the cam hits the receiver to limit the lift of the handle.

d. Bolt Sleeve. The bolt sleeve (fig. 43) is bored to receive the mainspring and safety indicator. It is serrated at its back end to prevent any reflection of light from its surface to interfere with the aiming of the rifle.

e. Firing Pin Group.

(1) The firing pin assembly consists of the firing pin and the firing pin point permanently assembled during manufacture (fig. 44). The firing pin has two undercuts to clear the ejector and the magazine walls. The sear notch toward the rear end of the firing pin holds the firing pin engaged with the sear against the pressure of the mainspring when the rifle is cocked. The rear of the firing pin is drilled to receive the mainspring plunger. A hole in the rear receives the firing pin cam pin.

DESCRIPTION AND FUNCTIONING

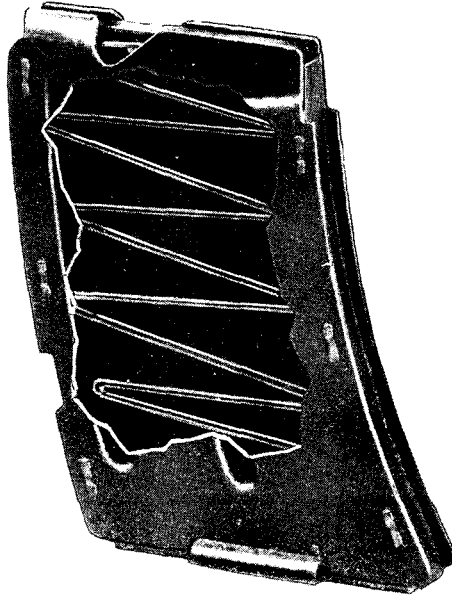

RA PD 01917

**Figure 45 – Magazine Assembly of Remington Rifle,
Cal. .22, Model 513T – Cutaway View**

(2) The safety indicator is located inside the mainspring. When the mainspring is compressed to the cocked position, the indicator protrudes through its hole in the rear of the bolt sleeve to indicate that the firing mechanism is cocked.

(3) The mainspring plunger has a slotted hole in the rear as a clearance hole for the bolt sleeve pin.

(4) The mainspring is between the firing pin pointer and the mainspring plunger. It is compressed by the action of the bolt handle forcing the firing pin and mainspring plunger to the rear. When its compression is released, it forces the firing pin forward.

16. MAGAZINE ASSEMBLY.

a. The magazine assembly includes the magazine tube, magazine follower, magazine spring, and magazine bottom (fig. 45).

b. The magazine spring maintains pressure against the follower and, when the magazine is loaded, forces the cartridges to the top. Lips on the sides of the magazine retain the top cartridge until the bolt, as it is closed, moves the cartridge forward to a slot on each side of the magazine permitting the cartridge rim to pass from the magazine and move into the firing chamber of the barrel.

17. REAR SIGHT ASSEMBLY.

a. The Redfield 75 RT sight (fig. 46) is secured to the mounting block on the rear end of the receiver by a knurled thumbscrew. The

CALIBER .22 RIFLES, ALL TYPES

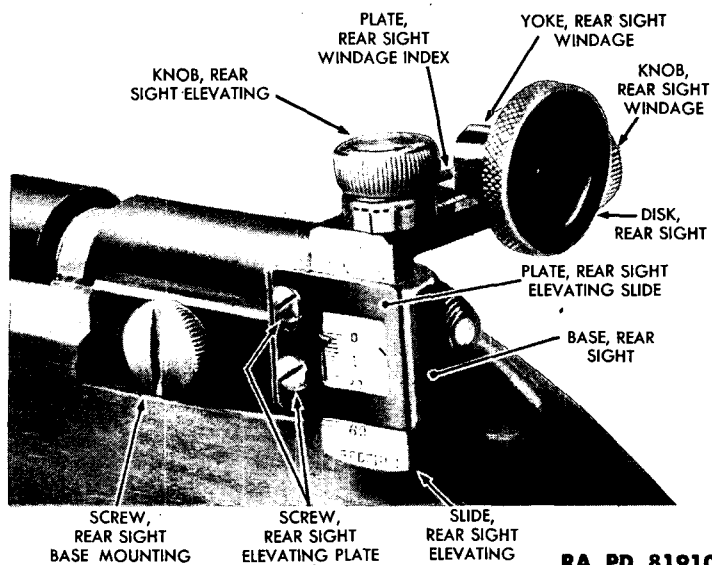

RA PD 81910

Figure 46 — Rear Sight Assembly Mounted on Remington Rifle, Cal. .22, Model 513T — Left Rear View

rear sight mounting block is attached to the rear end of the receiver by two screws. It is provided with two tapped holes, in either of which the rear sight may be mounted.

b. The rear sight elevating slide fits into a recess in the rear sight base and is moved up and down by means of the rear sight elevating knob and screw. The rear sight elevating slide plate is mounted to the base by two screws. The holes in this plate are elongated and provide means of moving the plate up and down for adjustment. The rear sight elevating slide plate pointer is an integral part of the plate. This pointer and the graduation lines on the elevating slide tell what elevation the sight is set to. The graduation lines are in minutes of angle.

c. The rear sight disk screws into the rear sight windage yoke which is so constructed that it slides over the top and bottom and into the slot of the rear sight elevating slide (fig. 47). The rear sight windage yoke and rear sight disk are moved laterally by means of the rear sight windage knob and screw which extends through the threaded yoke. The front end of the yoke has a line scribed at its center. This line and the graduation lines on the rear sight windage index plate tell to what windage position the sight is set. The rear sight windage index plate is mounted on the front of the rear sight elevating slide by the rear sight windage index plate screw. The rear

DESCRIPTION AND FUNCTIONING

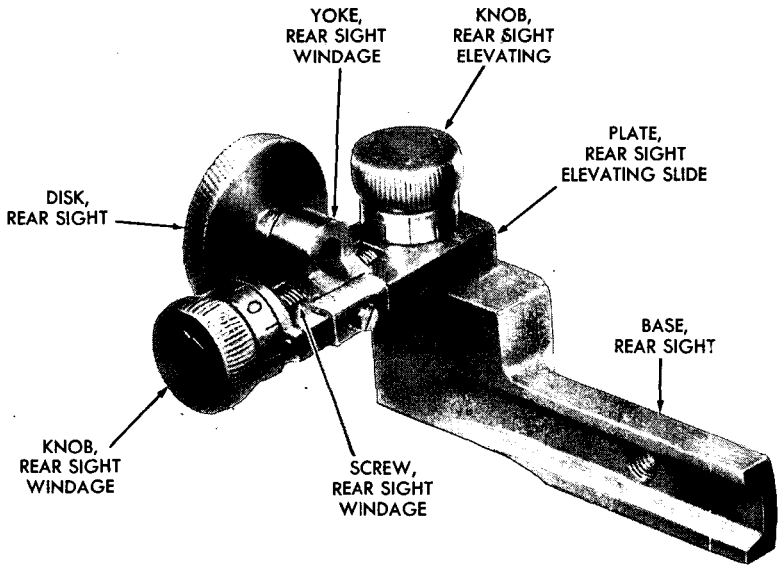

RA PD 81968

Figure 47 — Rear Sight Group of Remington Rifle, Cal. .22, Model 513T — Right Front View

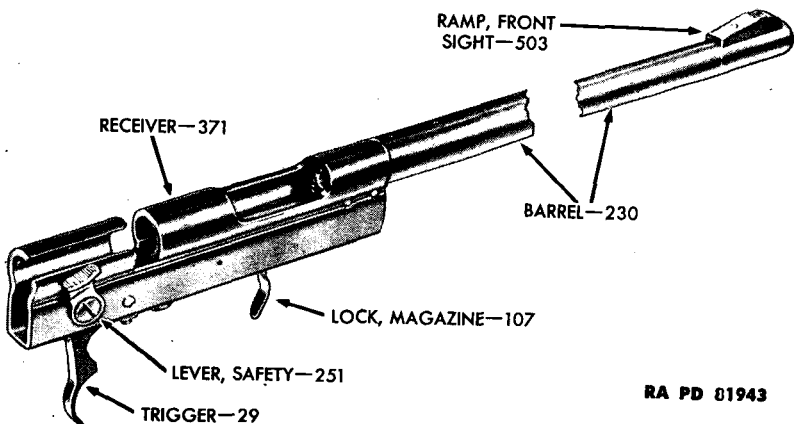

RA PD 81943

Figure 48 — Barrel and Receiver Group of Remington Rifle, Cal. .22, Model 513T

sight windage index plate screw hole is elongated and provides means of moving the plate backwards and forward for adjustment.

d. The elevating and windage screws are controlled by micrometer graduated dial knobs fastened by set screws. Detent balls under

CALIBER .22 RIFLES, ALL TYPES

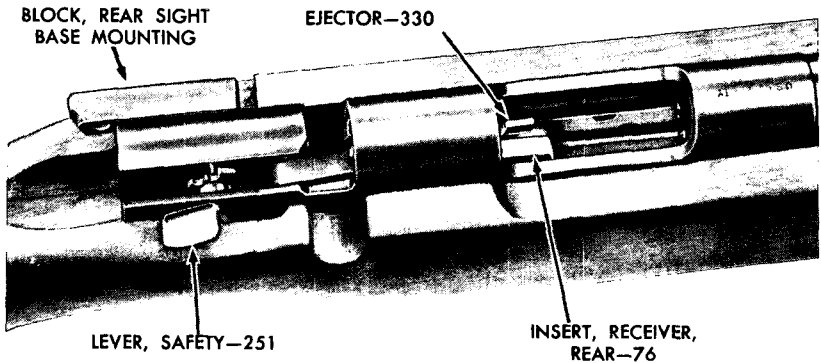

RA PD 81906

Figure 49 – Receiver Section of Remington Rifle, Cal. .22, Model 513T – Bolt Removed – Top View

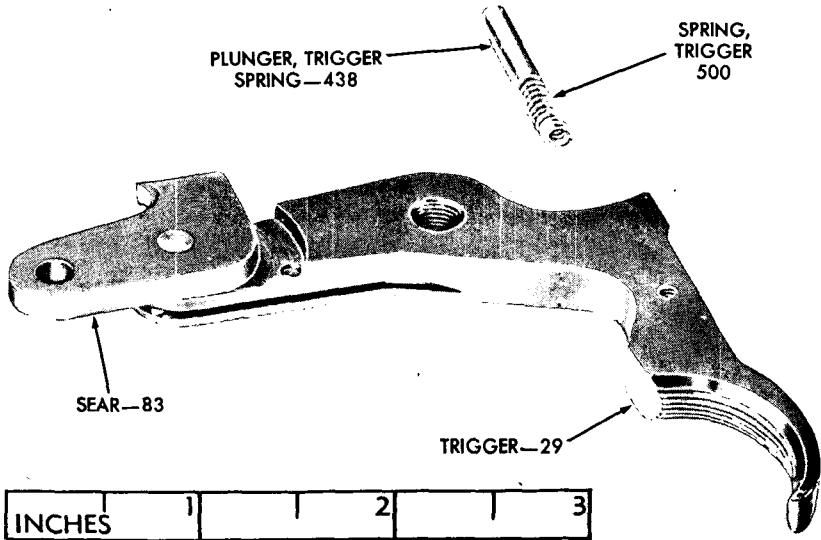

RA PD 81940

Figure 50 – Sear and Trigger Group of Remington Rifle, Cal. .22, Model 513T

these knobs act as clicks, so that a distinct click is heard when the knobs are turned. Each click equals one-sixteenth inch at 25 yards, one-eighth inch at 50 yards, one-half inch at 100 yards, etc.

18. BARREL AND RECEIVER GROUP.

a. The barrel and receiver group includes the barrel, receiver, front sight, trigger mechanism group, safety lock group, magazine lock, front and rear receiver inserts, and ejector (fig. 48).

b. **Barrel.** The barrel is 27 inches long and the rifling consists of six plain grooves 0.0025 inch deep. The twist is uniform right

DESCRIPTION AND FUNCTIONING

hand, one turn in 16 inches. The breech of the barrel is recessed to receive the ends of the two extractors. The barrel is pressed into the receiver and held in place by means of two pins.

c. Receiver. The receiver is machined out to receive the bolt group and is slotted to provide for the bolt handle (fig. 49). Holes are drilled in the receiver to provide means of mounting the rear sight block, safety, trigger, and ejector.

d. Front Sight. The front sight is of the ramped blade type and is secured to the front end of the barrel by means of two screws. Serrations on the back end of the ramp prevent any reflections of light from its surface that might interfere with the aiming of the rifle.

e. Trigger Mechanism Group. The trigger mechanism group includes the trigger, sear, trigger take-up spring, trigger spring plunger, trigger spring, and trigger cushion spring group (fig. 50). The trigger is pivoted on a pin which is pressed through the side of the receiver. The back of the sear is installed on the front end of the trigger by means of a pin. The front of the sear is mounted on the sear pivot screw. This permits the sear to pivot on the forward end of the trigger when the trigger is pulled. The upper portion of the sear extends into the receiver well where it can engage with the sear notch in the firing pin. A trigger spring and trigger spring plunger are located in the trigger heel. (A trigger take-up spring in bottom of trigger gives tension between trigger and sear.) This plunger contacts the safety lock mounted in the right wall of the receiver and the plunger spring puts a tension on the trigger. A trigger cushion spring is mounted on the bottom of the receiver by means of a screw. Screws in both ends of this spring engage the trigger and sear and may be adjusted to secure any desired trigger pull.

NOTE: In rifles of early manufacture, the trigger cushion spring group is composed of a cylindrical housing which is screwed into the receiver and locked in place by a lock nut. Within the housing is assembled a plunger, spring, and retaining screw. Adjustment is obtained by means of the retaining screw.

f. Safety Lock. The safety lock is mounted in the receiver by means of a safety lock screw which also holds the safety lever on the outside of the receiver and attaches the lever to the lock. The safety lever is keyed to permit it to engage in two slots in the safety lock. When the safety lever is moved to the "safe" position, the safety lock engages the top of the trigger, preventing movement.

g. Magazine Lock. The magazine lock (spring) is mounted by two screws on the bottom of the rear receiver insert and serves to retain the magazine in position in the rifle.

h. Ejector. The ejector is mounted in the bottom of the receiver well on the rear receiver insert by means of the ejector screw and the

CALIBER .22 RIFLES, ALL TYPES

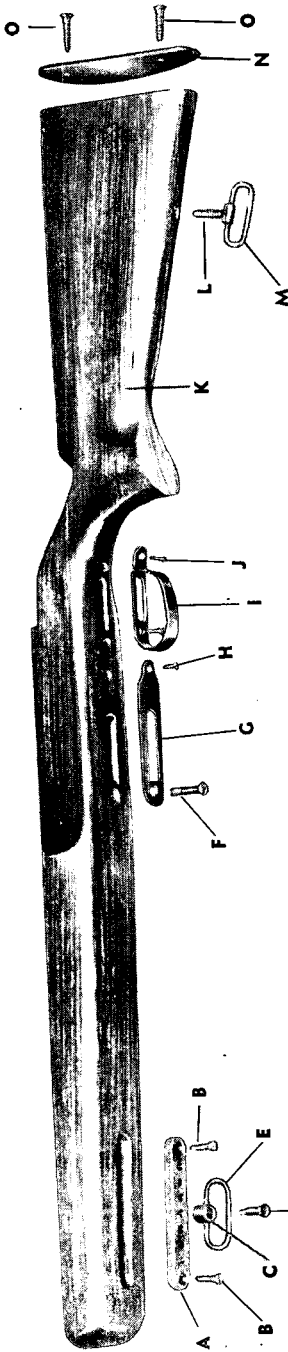

- A — BASE - REM-232
- B — SCREW - REM-233
- C — COLLAR - REM-234
- D — SCREW - REM-113
- E — SWIVEL - REM-112
- F — SCREW - REM-393
- G — PLATE - REM-2105
- H — SCREW - REM-106
- I — GUARD - REM-229
- J — SCREW - REM-97
- K — STOCK - REM-235
- L — SCREW - REM-117
- M — SWIVEL - REM-116
- N — PLATE - REM-308
- O — SCREW - REM-9

RA PD 22736

Figure 51 — Stock Group of Remington Rifle, Cal. .22, Model 513T — Exploded View

DESCRIPTION AND FUNCTIONING

sear pivot screw. The sear pivot screw passes through the pivot hole in the sear, the ejector, and the rear receiver insert. The screwhead screws into the left side of the receiver.

19. STOCK GROUP.

a. The stock group includes the stock, the front and rear swivels, magazine guide plate, trigger guard, and butt plate (fig. 51).

b. The stock is cut out at the top for the barrel and receiver. The side of the stock is cut away for the bolt handle. The front of the bottom of the stock is mortised to receive the front swivel base.

c. The front swivel is attached to front swivel base by means of a screw. Seven tapped holes in the swivel base permit moving the swivel for adjustment of handhold with relation to the sling. The rear swivel is attached to the stock by means of a screw which is part of the assembly.

d. The magazine guide plate is attached to the bottom of the stock by one wood screw and the screw which retains the barrel and receiver in the stock.

e. The trigger guard is attached to the bottom of the stock by means of two wood screws.

f. The butt plate is attached to the rear of the stock by two butt plate screws.

20. FUNCTIONING (fig. 39).

a. When the bolt handle is raised to the unlocked position, the sleeve portion of the handle rotates around the bolt which is prevented from turning by the engagement of the ejector with the grooved bottom of the bolt. A pin extending through the rear of the firing pin and through slots in the bolt wall engages the cam surface in the handle sleeve. The rotation of this cam, when the handle is raised, forces the firing pin to the rear against the plunger and indicator, compressing the mainspring and setting the firing pin in firing position. When the firing pin has reached its cocked position, the sear notch is directly over the sear which then rises under the indirect action of the trigger spring, and enters the notch. The trigger, being pivoted on the sear, returns to firing position at the same time.

b. As the bolt is retracted, the cartridge case, held against the bolt head by the two extractors, is extracted from the chamber. Just before the bolt is fully retracted, the cartridge case strikes the ejector and as the bolt is further retracted, the cartridge rim is forced out from the sloping claw of the left extractor, is pivoted to the right around the right extractor hook, and thrown out of the receiver upward and to the right. The engagement of the sear nose with the lug between the magazine clearance grooves prevents full withdrawal of the bolt from the receiver.

CALIBER .22 RIFLES, ALL TYPES

c. As the bolt uncovers the magazine during retraction, the magazine spring and follower raise a cartridge partially out of the magazine where the rim is retained between the lips formed on the walls so that the cartridge is held in an inclined position with the bullet extending up and out of the magazine. When the bolt is pushed forward, the lug on the bottom of the bolt head pushes the cartridge forward until the rim is released at the end of the magazine lips and forced up under pressure of the magazine spring into the recess in the bolt head face and under the extractors. Further closing of the bolt seats the cartridge in the barrel chamber. Turning the handle down locks the bolt, leaving the firing pin held by the sear notch in position for firing.

d. When the trigger is pulled to the rear, it pivots on its mounting pin dropping its front end down. This causes the back of the sear, which pivoted on the trigger, to be disengaged from the sear notch in the firing pin. Then tension of the mainspring is then released and forces the firing pin forward to strike the cartridge.

Section IV

STEVENS RIFLE, CAL. .22, MODEL 416-2

21. GENERAL.

a. The Stevens Rifle, cal. .22, Model 416-2 (fig. 52) differs from the U.S. rifle and other commercial rifles in its detailed construction of parts although basically the same in mechanical operation and functioning.

22. BOLT ASSEMBLY.

a. **General.** The bolt assembly of the Stevens rifle may be removed as a unit (fig. 53). It is a semipermanent assembly and its disassembly should not be undertaken in the field. It includes the bolt head group, bolt handle and body group, and firing mechanism group.

b. Bolt Head Group.

(1) This group consists of the bolt head and two extractors (fig. 54).

(2) On the under side of the bolt are cut the magazine clearance grooves which permit the bolt to pass over the magazine. The lug between the grooves acts to remove the cartridge from the magazine.

(3) On the rear is the hole for the bolt head retaining pin and the slot for the bolt head stop plunger. The head is bored to receive the firing pin, firing pin spring, firing pin extension, and the undercut portion of the bolt handle and body.

DESCRIPTION AND FUNCTIONING

(4) The front of the bolt head is chambered to receive the cartridge rim and has the firing pin hole through which the firing pin passes to strike the cartridge. The extractors are mounted in slots in the front of the bolt head and are retained in place by the tension of the extractor plunger springs and extractor plungers.

c. Bolt Handle and Body Group.

(1) This consists of the bolt handle and bolt body permanently assembled during manufacture (fig. 55). On the back of the bolt handle is a cam which operates on the rear of the bolt handle slot in the receiver and forces the bolt to its extreme forward position to finish cocking the rifle when the bolt handle is returned to closed position. At the forward position of the bolt body is the extension upon which the bolt head is assembled. This extension is slotted to receive the bolt head retaining pin. The bolt head stop plunger and spring are assembled in a hole in the front. The plunger engages its slot in the rear of the bolt head when the bolt handle is raised.

(2) A sear recess is cut in the bolt handle and body to form a ramp on which the sear rides when the bolt is moved forward or backward. Just ahead of the ramp, a slot provides clearance for the sear nose to hold the striker in cocked position when the bolt handle is lowered after cocking.

(3) A slot at the rear of the bolt body permits the installation of the striker and mainspring retainer which holds the mainspring, striker, and striker collar in position in the bolt body. The cam at the extreme rear, acting on the cocking piece which is held stationary by its slot in the receiver, cocks the rifle when the bolt handle is raised.

d. Firing Mechanism Group.

(1) This group consists of the firing pin spring, firing pin, firing pin extension, striker, mainspring, striker collar, striker and mainspring retainer, and the cocking piece (fig. 56).

(2) The firing pin spring is a small coil spring assembled over the small end of the firing pin and acts to keep the firing pin against the firing pin extension when the rifle is cocked.

(3) The firing pin is machined with three different diameters. The front diameter acts as the striker, the center diameter acts as a bearing for the firing pin when it is in the bolt head, and the rear diameter forms a shoulder to limit the forward movement against a shoulder in the bolt head.

(4) The firing pin extension is assembled in the front of the bolt handle and is what its name implies: an extension between the rear end of the firing pin and the front end of the striker.

(5) The striker has two diameters. The forward or large diameter acts as the front bearing of the striker in the bolt body. In this same diameter, the sear notch is cut for engaging the sear when the rifle is cocked. The small diameter receives the mainspring. In

CALIBER .22 RIFLES, ALL TYPES

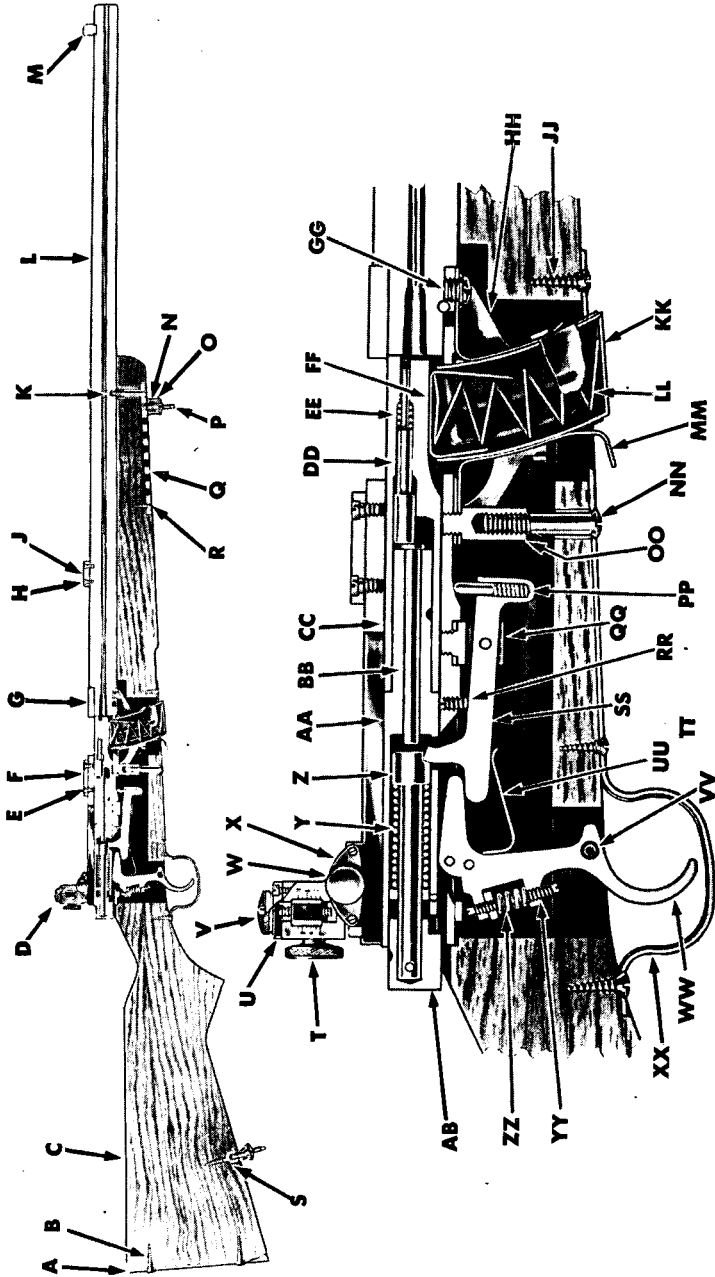

RA PD 81970

Figure 52 — Stevens Rifle, Cal. .22, Model 416-2 — Sectional View

DESCRIPTION AND FUNCTIONING

- A**—PLATE, BUTT
B—SCREW, BUTT PLATE
C—STOCK
D—SIGHT, REAR, ASSEMBLY
E—SCREW, TELESCOPE DOVETAIL BLOCK (REAR)
F—BLOCK, TELESCOPE DOVETAIL, REAR
G—RECEIVER
H—SCREW, TELESCOPE DOVETAIL BLOCK (FRONT)
J—BLOCK, TELESCOPE DOVETAIL, FRONT
K—SCREW, BARREL
L—BARREL
M—SIGHT, FRONT (BLADE TYPE)
N—COLLAR, SWIVEL
O—SCREW, SWIVEL
P—LOOP, SWIVEL
Q—PLATE, SWIVEL
R—SCREW, SWIVEL PLATE
S—ESCUTCHEON, SWIVEL, REAR
T—DISK, REAR SIGHT
U—SLIDE, REAR SIGHT WINDAGE (DOVETAIL)
V—KNOB, REAR SIGHT ELEVATING SCREW
W—KNOB, REAR SIGHT WINDAGE SCREW
X—CLICK, REAR SIGHT WINDAGE SCREW KNOB
Y—MAINSRING
Z—STRIKER
AA—BODY, BOLT
BB—EXTENSION, FIRING PIN
CC—HEAD BOLT
DD—PIN, FIRING
EE—SPRING, FIRING PIN
FF—FOLLOWER, MAGAZINE
GG—SCREW, MAGAZINE HOUSING
HH—HOUSING, MAGAZINE (WITH EJECTOR)
JJ—SCREW, GUARD (LONG)
KK—PLATE, FLOOR, MAGAZINE
LL—SPRING, MAGAZINE FOLLOWER
MM—RETAINER, MAGAZINE
NN—SCREW, MAGAZINE RETAINER POST
OO—POST, MAGAZINE RETAINER
PP—SPRING, SEAR
QQ—POST, SEAR
RR—SCREW, SEAR STOP
SS—SEAR
TT—SCREW, GUARD (SHORT)
UU—SPRING, TRIGGER
VV—SCREW, TRIGGER SIDE PLAY (2)
WW—TRIGGER
XX—GUARD
YY—PLUNGER, TRIGGER STOP
ZZ—SPRING, TRIGGERSTOP PLUNGER
AB—PIECE, COCKING

RA PD 91970A

Nomenclature for Figure 52 — Stevens Rifle, Cal. .22, Model 416-2 — Sectional View

CALIBER .22 RIFLES, ALL TYPES

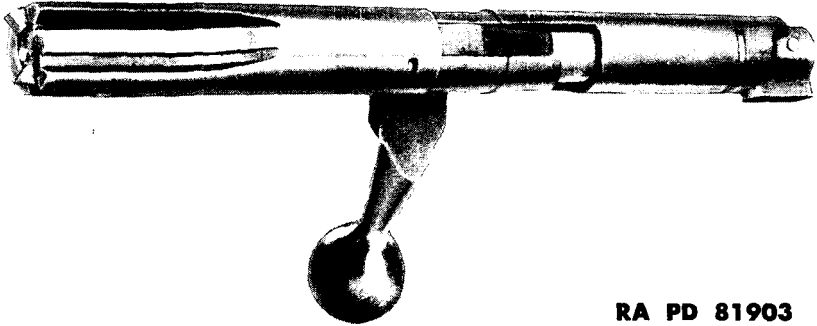

RA PD 81903

Figure 53 – Bolt Assembly of Stevens Rifle, Cal. .22, Model 416-2

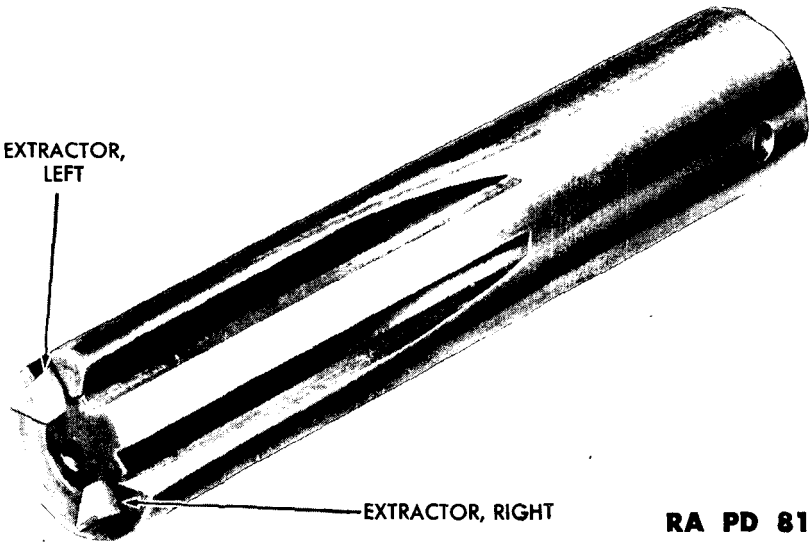

RA PD 81885

**Figure 54 – Bolt Head Group of Stevens Rifle,
Cal. .22, Model 416-2**

the end of the striker, a hole is drilled to receive the cocking piece retaining pin. At the end of the mainspring is placed the striker collar. The striker, mainspring, and striker collar are assembled in the bolt body and retained in place by the striker and mainspring retainer.

(6) The cocking piece is bored out and assembled over the end of the striker where it is attached by the cocking piece pin. The lug on the bottom of the cocking piece enters a groove in the bottom of the receiver and keeps itself and the striker from turning when the rifle is being cocked by raising the bolt handle. A red dimple

DESCRIPTION AND FUNCTIONING

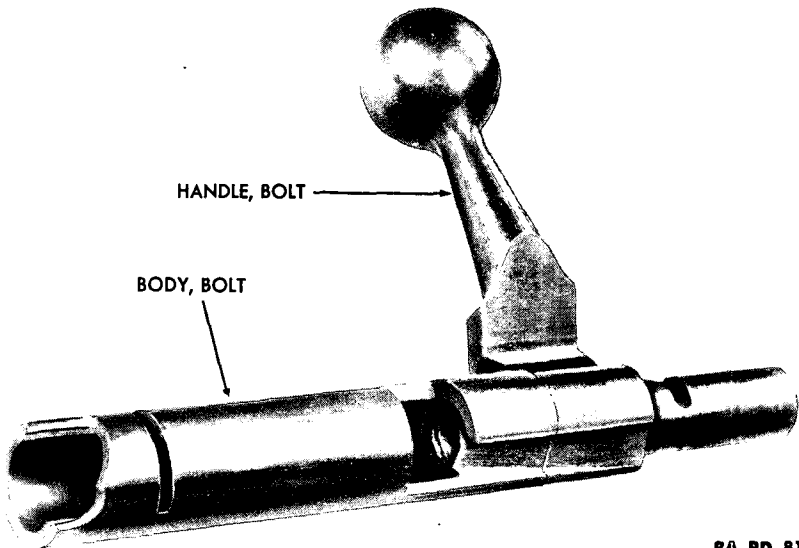

RA PD 81960

**Figure 55 — Bolt Handle and Body Group of Stevens Rifle,
Cal. .22, Model 416-2**

in the top of the cocking piece indicates when the firing mechanism is in the cocked position.

23. MAGAZINE ASSEMBLY.

a. The magazine assembly consists of the magazine tube (assembly), magazine follower, magazine follower spring, and magazine floor plate (fig. 57).

b. The magazine tube (assembly) consists of four walls: front, rear, left, and right. The magazine follower is retained in these four walls, and forces cartridges to the top of the magazine, by the action of the magazine follower spring. Lips retain the top cartridge until it is moved forward to a slot in each side of the magazine permitting the cartridge rim to pass out of the magazine. The magazine floor plate retains the follower spring in position.

24. REAR SIGHT GROUP ASSEMBLY.

a. The rear sight group assembly is a Stevens rear sight. It consists of the rear sight base with two (mounting) screws, and the rear sight windage slide group which includes the elevating parts (fig. 58).

b. The inside of the rear sight base is machined to fit the contour of the receiver to which it is attached by two screws. The upper portion of the base is recessed to receive the rear sight windage slide.

c. The rear sight windage slide is an inverted L-shaped part, the

CALIBER .22 RIFLES, ALL TYPES

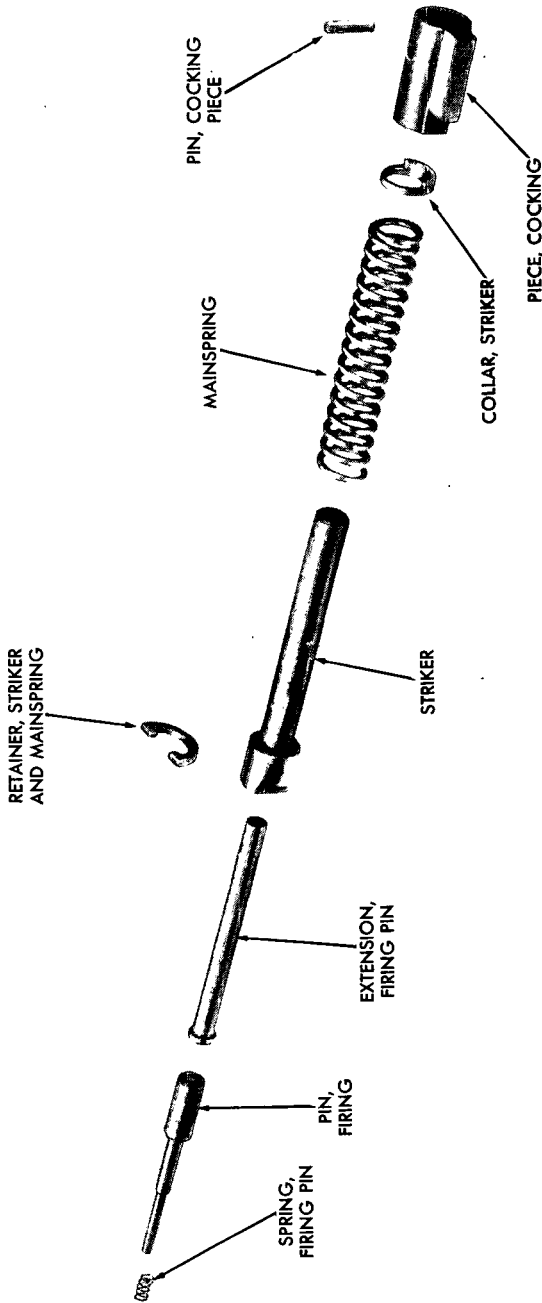

RA PD 81883

Figure 56 — Firing Mechanism Group of Stevens Rifle, Cal. .22, Model 416-2 — Exploded View

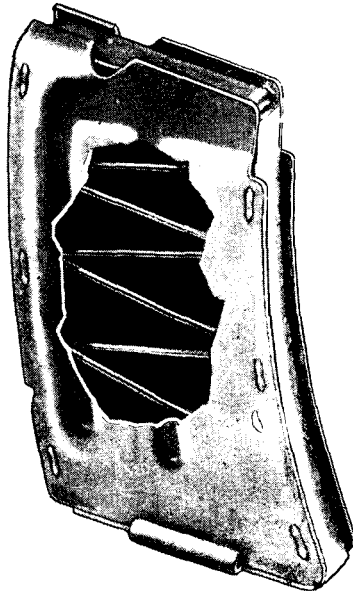
DESCRIPTION AND FUNCTIONING

RA PD 81916

Figure 57 – Magazine Assembly of Stevens Rifle, Cal. .22, Model 416-2 – Cutaway View

bottom of which is machined to fit into its recess in the rear sight base. A hole in the bottom right side is drilled and tapped to receive the rear sight windage screw. A slot in the bottom opposite this hole is provided for the screw to operate in.

d. Over the end of the windage screw and onto the right side of the base are mounted the rear sight windage screw bridge, click, and knob. The click and bridge are attached by means of two rear sight windage screw bridge screws. The rear sight windage screw knob is attached to the rear sight windage screw by means of a pin. When the knob is turned, either to the right or left, it moves the rear sight windage slide by means of the rear sight windage screw. When the knob is turned a distinct click is heard, as there are six small grooves cut in the rear face of the knob which engage the click.

e. The upper portion of the rear sight windage slide is cut out to receive the rear sight elevating slide which is grooved to fit into and over the sides of the cut-out. The back of the elevating slide is drilled and tapped to receive the rear sight disk assembly and the right side is drilled and tapped to receive the rear sight elevating screw (fig. 59). The elevating slide moves up and down when the elevating screw is turned by means of the rear sight elevating screw knob, the elevation being indicated on the scale on the right side of the windage slide.

CALIBER .22 RIFLES, ALL TYPES

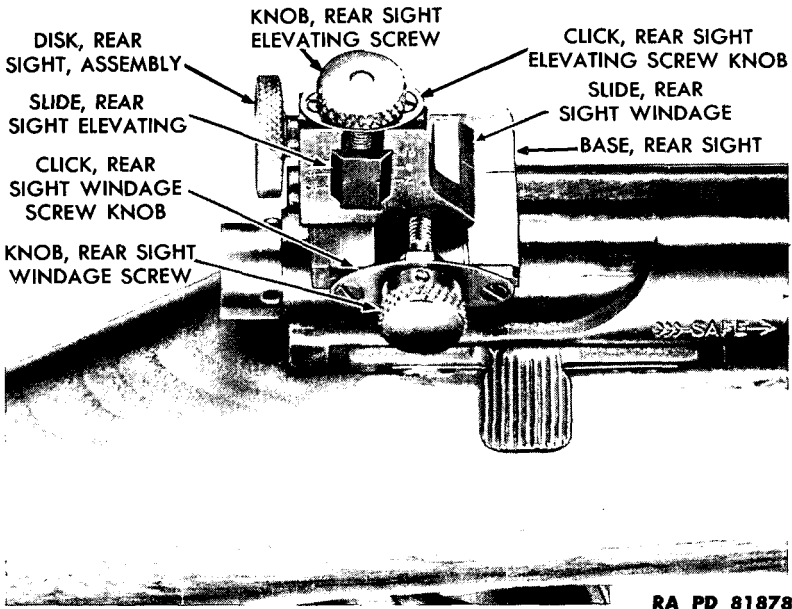

RA PD 81878

Figure 58 – Rear Sight Group Assembly Mounted on Stevens Rifle, Cal. .22, Model 416-2 – Right Top View

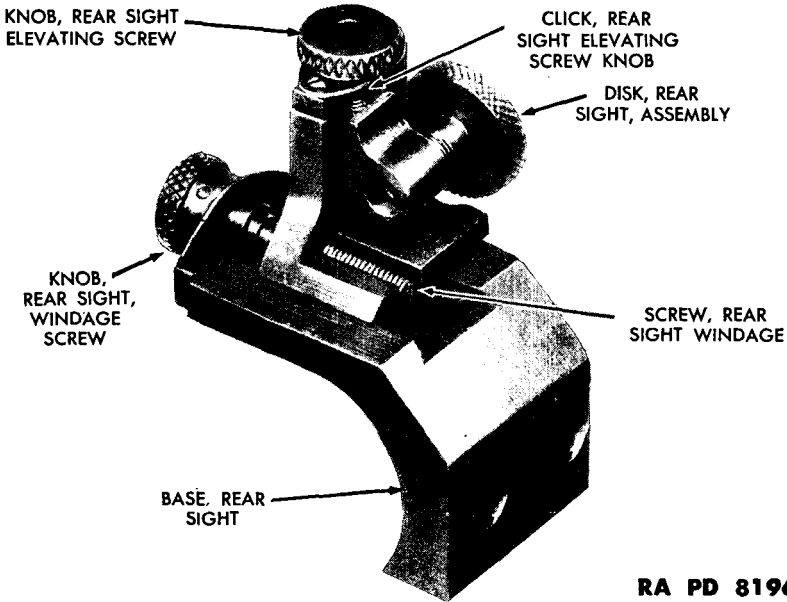

RA PD 81967

Figure 59 – Rear Sight Assembly of Stevens Rifle, Cal. .22, Model 416-2 – Left Front View

DESCRIPTION AND FUNCTIONING

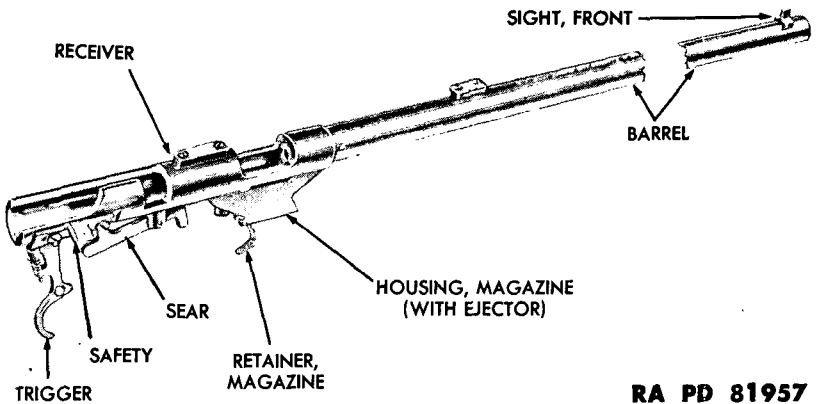

RA PD 81957

Figure 60 – Barrel and Receiver Group of Stevens Rifle, Cal. .22, Model 416-2

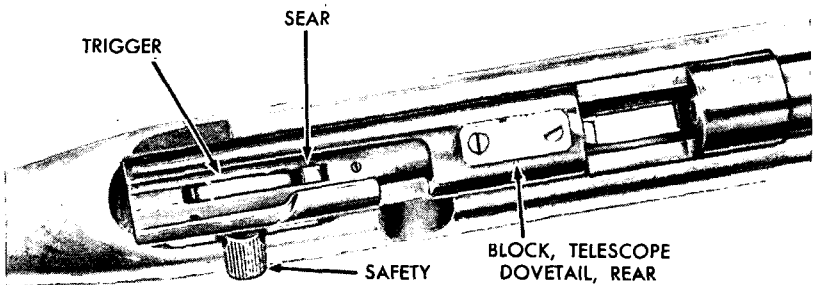

RA PD 81907

Figure 61 – Receiver Section of Stevens Rifle, Cal. .22, Model 416-2 – Bolt Removed – Top View

f. Over the top of the elevating screw, the rear sight elevating screw knob click and the rear sight elevating screw bridge are mounted to the top of the rear sight windage slide by means of two screws. The rear sight elevating screw knob is attached to the end of the screw by means of a pin. Six small grooves cut in the rear face of the knob contact the raised portion of the click, so that a distinct click is heard when the knob is turned.

25. BARREL AND RECEIVER GROUP.

a. The barrel and receiver group consists of the barrel and receiver, trigger mechanism group, safety group, and magazine housing group (fig. 60).

b. Barrel and Receiver.

(1) This is a permanent assembly pressed together and secured by means of a pin. The barrel is 26.12 inches long and the rifling

CALIBER .22 RIFLES, ALL TYPES

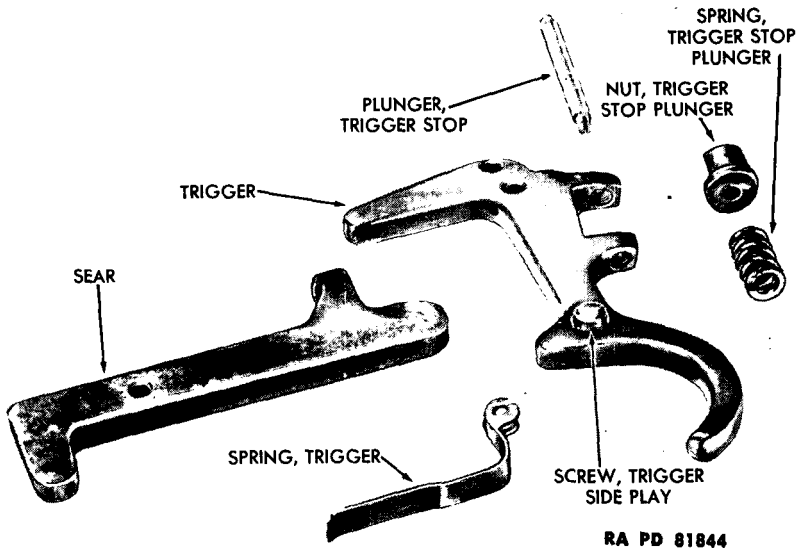

Figure 62 – Sear and Trigger Group of Stevens Rifle, Cal. .22, Model 416-2 – Exploded View

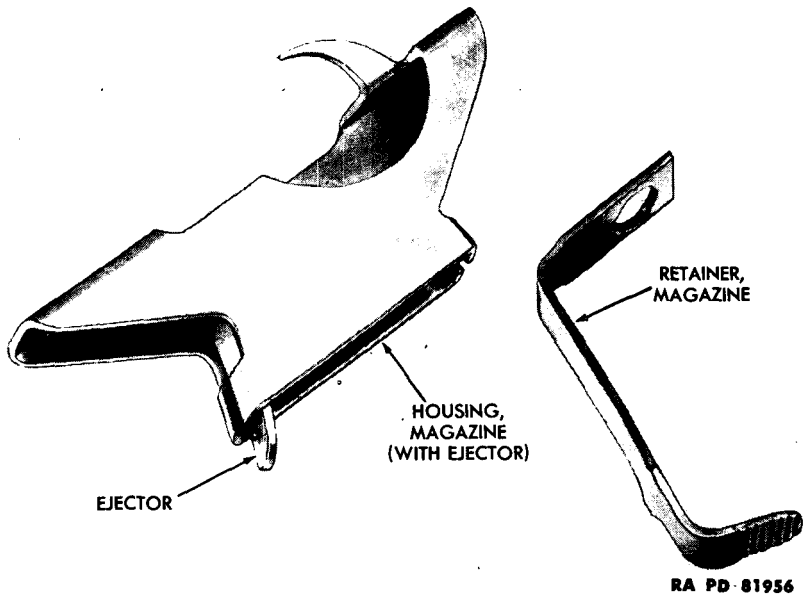

Figure 63 – Magazine Housing and Magazine Retainer Group of Stevens Rifle, Cal. .22, Model 416-2 – Exploded View

DESCRIPTION AND FUNCTIONING

consists of six plain grooves 0.0025 inch deep. The twist is uniform right hand, one turn in 16 inches. The breech of the barrel is recessed to receive the ends of the two extractors in the bolt.

(2) A dovetail groove is provided in the front of the barrel for mounting the front sight which may be either of the blade or hood types. The hood type is composed of a hood with a lateral slot in the center of the hood to receive one of five inserts (fig. 12). The inserts have two holes in the bottom corners to engage spring functioned detent balls assembled in the rear of the hood and projecting into the slot. The balls are held in position by a spring and screw.

(3) A front telescope dovetail block is attached at the rear of the barrel by means of two screws for the purpose of mounting a telescope (sight) if desired.

(4) The receiver is machined out to receive the bolt assembly (fig. 61). A slot in the lower portion of the receiver well acts as a stop to keep the cocking piece from turning when the rifle is cocked. On the top of the receiver, the rear telescope dovetail block is mounted by means of two screws. Two drilled and tapped holes are provided on the left side for mounting the rear sight. A recess and two holes are provided on the right side as a means for mounting the safety. A slot in the bottom at the rear provides a means for mounting the trigger assembly. The sear stop screw is permanently assembled just forward of the sear post which projects from the bottom of the receiver. A flat surface is machined on the forward bottom part of the receiver for the sear spring plunger to rest on and for the mounting of the magazine housing. On this flat surface, the magazine and ejector slots are cut out.

c. Trigger Mechanism Group.

(1) This group consists of the trigger assembly and the sear (fig. 62).

(2) The trigger assembly consists of the trigger, trigger stop plunger, trigger stop plunger nut, trigger stop plunger spring, the trigger spring, two trigger side play screws, and the trigger side play screw spring.

(3) The trigger is mounted in its slot in the bottom of the receiver by means of a trigger pin.

(4) The trigger stop plunger, nut, and spring are assembled to a tapped hole in the boss at the rear of the trigger. Adjusting the trigger stop plunger sets the amount of trigger travel.

(5) The trigger side play screws and spring are assembled in a tapped hole in the lower part of the trigger and serve as a means of adjusting the side play of the trigger.

(6) The trigger spring is pinned to the top of the trigger and acts against the sear which in turn maintains a pressure on the trigger.

(7) The sear is secured to the sear post on the bottom of the receiver by means of a pin.

CALIBER .22 RIFLES, ALL TYPES

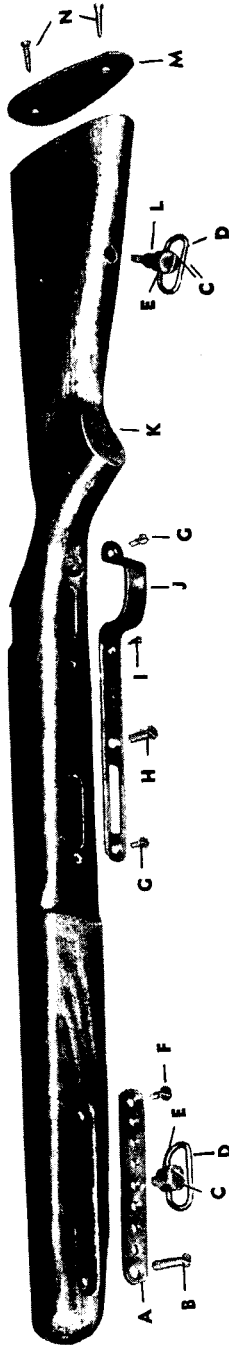

- A — PLATE, SWIVEL
- B — SCREW, BARREL
- C — SCREW, SWIVEL
- D — LOOP, SWIVEL
- E — COLLAR, SWIVEL
- F — SCREW, SWIVEL PLATE
- G — SCREW, GUARD, LONG
- H — SCREW, MAGAZINE RETAINER POST
- I — SCREW, GUARD, SHORT
- J — GUARD
- K — STOCK
- L — ESCUTCHEON, SWIVEL
- M — PLATE, BUTT
- N — SCREW, BUTT PLATE

RA PD 22742

Figure 64 — Stock Group of Stevens Rifle, Cal. .22, Model 416-2 — Exploded View

DESCRIPTION AND FUNCTIONING

(8) The sear spring plunger and sear spring are mounted in a hole in the forward portion of the sear. Pressure of this spring and plunger against the bottom of the receiver keeps the sear nose in its extreme upright position against its stop on the receiver.

d. **Safety Group.** The safety and safety spring are mounted on the side of the receiver by means of two screws. The screw holes in the safety are elongated permitting it to move to the front or rear. When moved forward or backward, the lug on the safety spring seats into one of two grooves in the safety keeping the trigger in the "ready" or "safe" position.

e. **Magazine Housing Group.** The magazine housing is a 1-piece stamping and serves with the magazine retainer to hold the magazine in position (fig. 63). It is mounted on the bottom of the receiver by means of the magazine retainer post and a magazine housing screw. On the top part of the magazine housing is the ejector which is formed as part of the housing and fits into a slot in the bottom of the receiver well. This acts to eject the cartridge case when the bolt is drawn backwards. The magazine retainer is mounted by means of the magazine retainer post, and retains the magazine in its housing. The magazine post retainer screw extends through guard and stock and threads into the post to hold stock and receiver together. Pressing on the serrated portion of this retainer releases the magazine from the housing.

NOTE: In rifles of recent manufacture, the magazine housing is fastened to the receiver by a short (front) and long (rear) cap screw. The barrel and receiver are held together at the rear by a barrel stud (similar in appearance to the magazine retainer post) which screws into the barrel just ahead of the receiver, and a barrel stud screw which extends through the front end of (trigger) guard and stock, and threads into the barrel stud. The barrel and stock are held together at the front end by a barrel band, screw, and nut in place of the barrel screw passing through the swivel plate and stock and threading into the under side of the barrel.

26. STOCK GROUP.

a. The stock group includes the stock, front swivel plate, front and rear swivels (trigger), guard, and butt plate (fig. 64).

b. The stock is cut out at the top to receive the barrel and receiver group. The side of the stock is cut away for the bolt handle. The front bottom of the stock is mortised to receive the front swivel plate.

c. The front swivel plate is mounted by means of the front barrel screw which extends through the stock and threads into the barrel, and the swivel plate screw. It has seven tapped holes for receiving the front swivel screw for adjustment of handhold with relation to the sling.

CALIBER .22 RIFLES, ALL TYPES

d. The front and rear swivels are both the same and serve as a means of attaching the sling to the rifle. The front swivel is mounted to the front swivel plate and the rear swivel is attached to the rear swivel escutcheon screwed into the butt of the stock.

e. The guard is mounted on the bottom of the stock. A cut-out in the guard serves as an opening for the magazine.

f. The butt plate is attached to the rear of the stock by means of two wood screws.

27. FUNCTIONING (fig. 52).

a. Raising the bolt handle rotates the rear portion of the bolt in the receiver. The bolt head is prevented from rotating because the ejector, which is part of the magazine housing, is seated in a slot in the bolt head. The firing pin is held against rotation because the cocking piece is held in a slot in the receiver. As the bolt handle is raised, a cam on the rear of the bolt engages the cocking piece forcing it and the striker to the rear and compressing the mainspring against the striker collar at the rear of the bolt body. This retraction of the striker permits the sear to enter the sear notch in the striker under pressure of the sear spring and plunger. As the back of the sear pivots upward, it returns the trigger to firing position.

b. As the bolt is retracted, the two extractors holding the cartridge against the bolt head, pull the case from the firing chamber of the barrel. Just before the bolt is fully retracted, the cartridge case strikes the ejector. As the bolt is further retracted, the cartridge rim is forced over the claw of the left extractor, is pivoted to the right around the right extractor hook, and thrown out of the receiver upward and to the right. The engagement of the sear nose with the back end of the bolt head stops the rearward movement of the bolt.

c. As the bolt uncovers the magazine during its retraction, the magazine spring and follower raises a cartridge partially out of the magazine where the rim is retained between the lips formed on the walls, and the cartridge is held in an inclined position with the bullet extending up and out of the magazine. When the bolt is pushed forward to its closed position, the lug on the bottom of the bolt head pushes the cartridge forward until the rim is released at the end of the magazine lips and forced up under pressure of the magazine spring into the recess in the bolt head face and under the extractors. As the bolt reaches its foremost position, the cartridge is seated in the chamber of the barrel.

d. Putting the bolt handle down to the locked position rotates the cocking cam surface away from the cocking piece leaving the striker held in the sear notch in firing position.

DESCRIPTION AND FUNCTIONING

e. When the trigger is pulled, its forward extension depresses the sear and disengages it from the sear notch in the striker. The main-spring then drives the striker against the firing pin extension which in turn drives the firing pin against the cartridge rim.

Section V

WINCHESTER RIFLE, CAL. .22, MODEL 75

28. GENERAL.

a. The Winchester Rifle, cal. .22, Model 75 (fig. 65) differs from the other commercial rifles in its detailed construction of parts although basically the same in its mechanical operation and functioning.

29. BREECH BOLT ASSEMBLY.

a. The breech bolt assembly consists of the breech bolt group, breech bolt cocking sleeve assembly, breech bolt sleeve, and firing pin group. It can be removed from the rifle as a unit (fig. 66).

b. **Breech Bolt Group.** The breech bolt group consists of the breech bolt and the extractors (fig. 67). The extractors are mounted in the two slots provided in the head of the breech bolt and are retained in place by two pins. A spring is mounted in a hole at the back end of each extractor. The forward portion of the bottom of the bolt is cut away for magazine and ejector clearance so that the bolt can slide over the magazine. The lug in the center serves to remove the cartridge from the magazine. The front end of the bolt is chambered to receive the cartridge rim and has the firing pin hole through which the striker end of the firing pin passes to strike the cartridge. The back portion is undercut to receive the breech bolt handle and the breech bolt sleeve. A hole in the front part of the undercut receives the firing pin stop pin. A hole in the rear receives the breech bolt sleeve pin. The breech bolt is bored out to receive the firing pin. A slot cut in the center at the bottom acts as a guide-way for the firing pin.

c. **Breech Bolt Cocking Sleeve Assembly.** The breech bolt cocking sleeve assembly consists of the breech bolt handle and the breech bolt cocking sleeve formed at the rear (fig. 68). The back of the bolt handle acts against a cam surface on the receiver to force the breech bolt forward when the handle is lowered. The breech bolt cocking sleeve has a slot and cam formed on its under side. When the bolt handle is lowered, the cam acts against the cocking piece in the top of the firing pin to bring the firing pin rearward against the pressure of the firing pin spring until the cocking piece on the firing

CALIBER .22 RIFLES, ALL TYPES

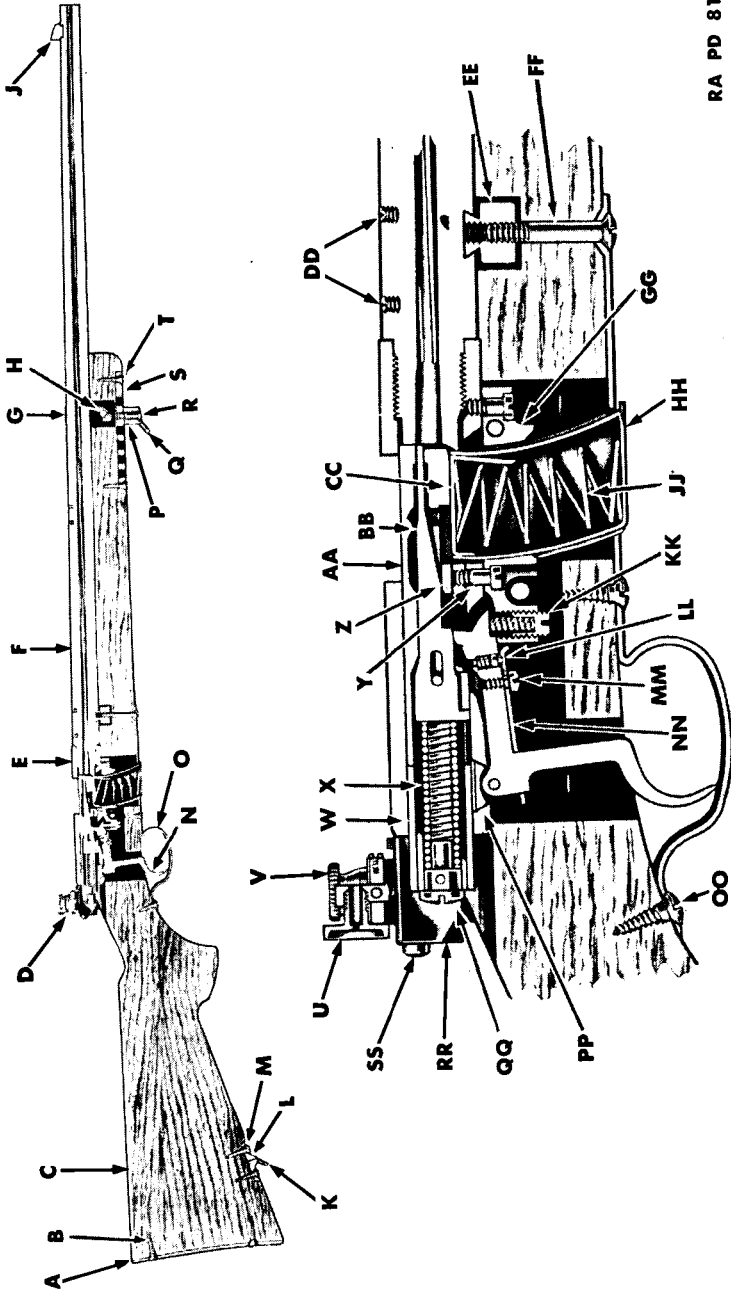

RA PD 81969

Figure 65 — Winchester Rifle, Cal. .22, Model 75 — Sectional View

DESCRIPTION AND FUNCTIONING

- | | | |
|---|--|--|
| A —PLATE, BUTT | R —SCREW, FOREARM ADJUSTMENT SWIVEL BOW BASE | EE —STUD, STOCK |
| B —SCREW, BUTT PLATE | S —BASE, FOREARM ADJUSTMENT | FF —SCREW, STOCK STUD |
| C —STOCK, SPECIAL LOW COMB | T —SCREW, FOREARM ADJUSTMENT BASE | GG —HOLDER, MAGAZINE |
| D —SIGHT, REAR, ASSEMBLY | U —DISK, REAR SIGHT | HH —MAGAZINE, ASSEMBLY |
| E —RECEIVER | V —KNOB, REAR SIGHT ELEVATING SCREW | JJ —SPRING, MAGAZINE |
| F —BARREL | W —SLEEVE, BREECH BOLT | KK —SCREW, TRIGGER SPRING ADJUSTING |
| G —BAND, BARREL | X —SPRING, FIRING PIN | LL —PLUNGER, SAFETY LOCK |
| H —SCREW, BARREL BAND | Y —SCREW, MAGAZINE HOLDER | MM —SCREW, SAFETY LOCK |
| J —BLADE, FRONT SIGHT | Z —EJECTOR | NN —LOCK, SAFETY |
| K —BOW, STOCK SWIVEL (1¼" STRAP) | AA —BOLT, BREECH | OO —SCREW, GUARD |
| L —BASE, STOCK SWIVEL | BB —PIN, FIRING | PP —BASE, TRIGGER |
| M —SCREW, STOCK SWIVEL BASE | CC —FOLLOWER, MAGAZINE | QQ —PLUG, BREECH BOLT |
| N —TRIGGER | DD —SCREW, FRONT AND REAR MOUNT BASE PLUG (TELESCOPE SIGHT) | RR —BASE, REAR SIGHT |
| O —GUARD | | SS —BOLT, REAR SIGHT LOCK |
| P —BASE, FOREARM ADJUSTMENT SWIVEL BOW | | |
| Q —BOW, FOREARM ADJUSTMENT SWIVEL | | |

RA PD 81969A

Nomenclature for Figure 65 — Winchester Rifle, Cal. .22, Model 75 — Sectional View

CALIBER .22 RIFLES, ALL TYPES

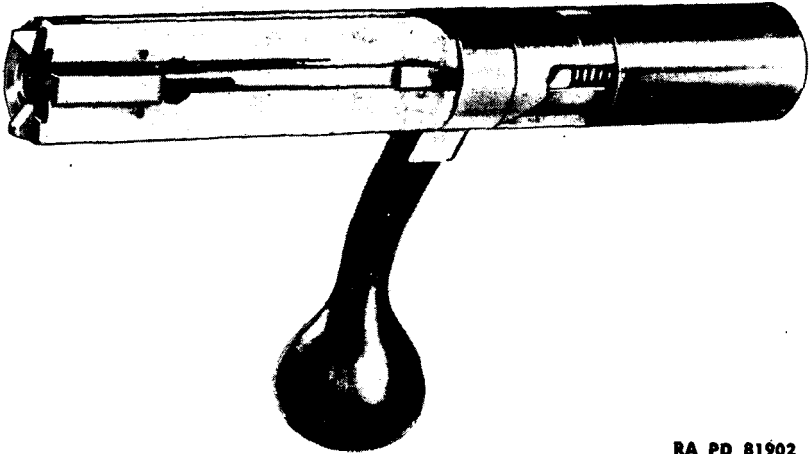

RA PD 81902

**Figure 66 – Breech Bolt Assembly of Winchester Rifle,
Cal. .22, Model 75**

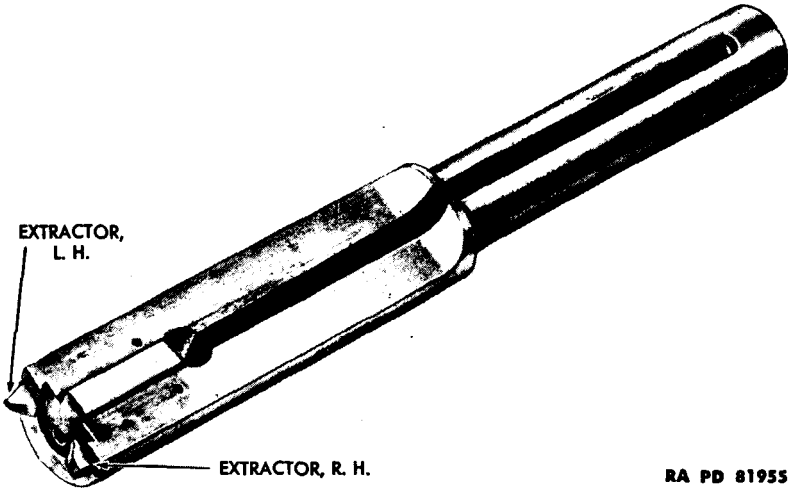

RA PD 81955

**Figure 67 – Breech Bolt Group of Winchester Rifle,
Cal. .22, Model 75**

pin is in the cocked position. A clearance notch for the safety lever is formed in the rear of the cocking sleeve just above the cocking cam.

d. **Breech Bolt Sleeve.** The breech bolt sleeve fits over the end of the breech bolt and is retained to it by the breech bolt sleeve pin (fig. 69). It acts as an enclosure for the firing pin spring (main-spring). The breech bolt plug is assembled in the end of the breech

DESCRIPTION AND FUNCTIONING

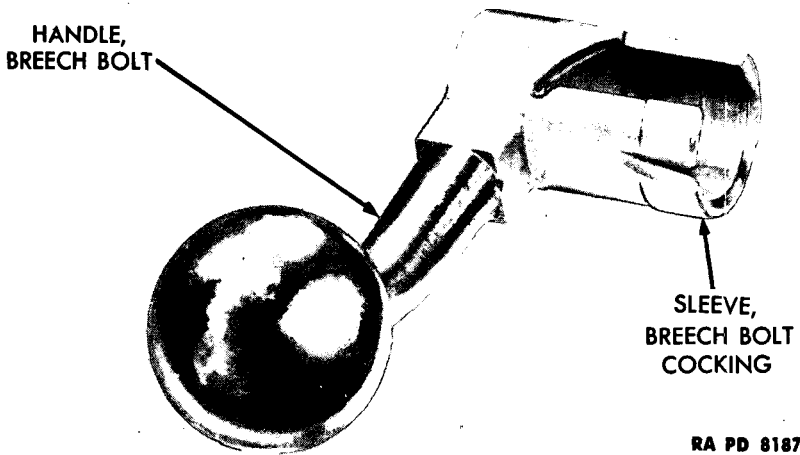

Figure 68 — Breech Bolt Cocking Sleeve Assembly of Winchester Rifle, Cal. .22, Model 75

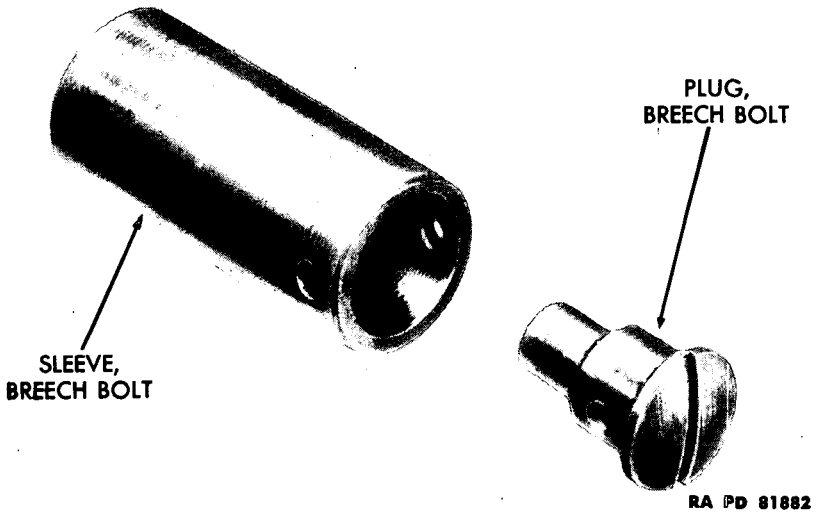
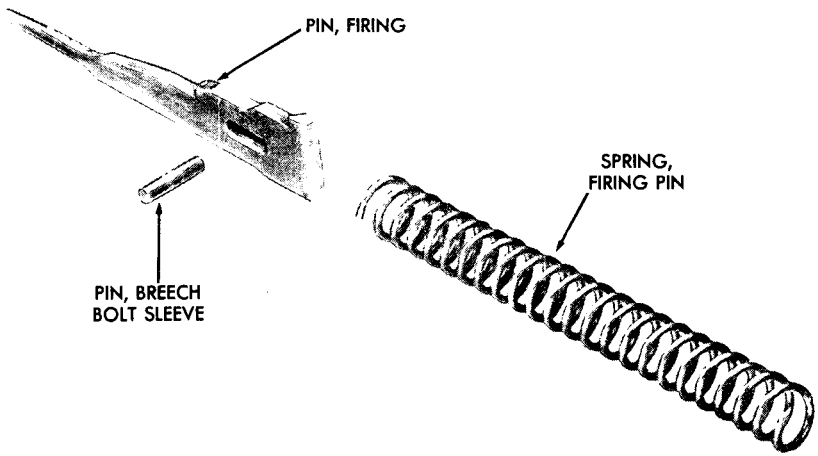

Figure 69 — Breech Bolt Sleeve and Breech Bolt Plug of Winchester Rifle, Cal. .22, Model 75

bolt sleeve and acts as the rear stop for the firing pin spring. It is retained in place by the same pin that retains the bolt sleeve.

e. **Firing Pin Group.** The firing pin group consists of the firing pin, firing pin stop pin, and the firing pin spring (fig. 70). The firing pin is of 1-piece construction. On the front end is formed the striker. The firing pin has flat surfaces, and these together with the slot formed

CALIBER .22 RIFLES, ALL TYPES



RA PD 81884

Figure 70 – Firing Pin Group of Winchester Rifle, Cal. .22, Model 75 – Exploded View Showing Position When Assembled in Breech Bolt

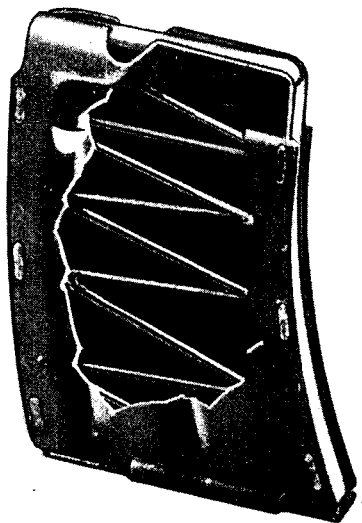

RA PD 81922

Figure 71 – Magazine Assembly of Winchester Rifle, Cal. .22, Model 75 – Cutaway View

in the breech bolt act as a guide for the firing pin in the breech bolt as well as to keep it from turning when the rifle is cocked. The firing pin stop pin which passes through a slotted hole in the rear of the firing pin, acts as a stop for the firing pin. A lug formed at the rear of

DESCRIPTION AND FUNCTIONING

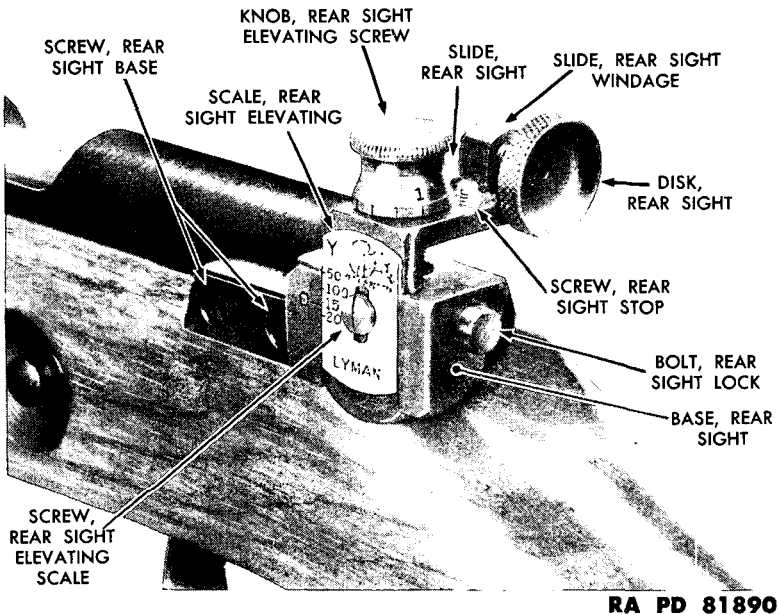

Figure 72 — Rear Sight Assembly Mounted on Winchester Rifle, Cal. .22, Model 75 — Left Rear View

the firing pin engages the sear. A small lug on the rear engages the cocking cam of the breech bolt cocking sleeve.

30. MAGAZINE ASSEMBLY.

a. The magazine assembly consists of the magazine sides, the magazine front and rear ties, magazine follower, magazine spring, and magazine base (fig. 71). The follower fits into the tube formed by the sides and ties and, by means of the pressure of the magazine spring on it, forces cartridges to the top. Lips retain the top cartridge until it is moved forward to a slot in each side of the magazine sides permitting the cartridge rim to pass out of the magazine. A lug formed on the left side of the magazine side engages a slot in the magazine catch on the magazine holder in the receiver to hold the magazine in position.

31. REAR SIGHT GROUP ASSEMBLY.

a. A Lyman 57E rear sight is mounted by two screws threading into two tapped holes on the left side of the receiver (fig. 72).

b. On the front of the rear sight elevating base is stamped "O," which, when in line with the elevating scale on the rear sight slide, gives the elevation to which the sight is set. The rear sight base is grooved on the left side to take the rear sight elevating slide and

CALIBER .22 RIFLES, ALL TYPES

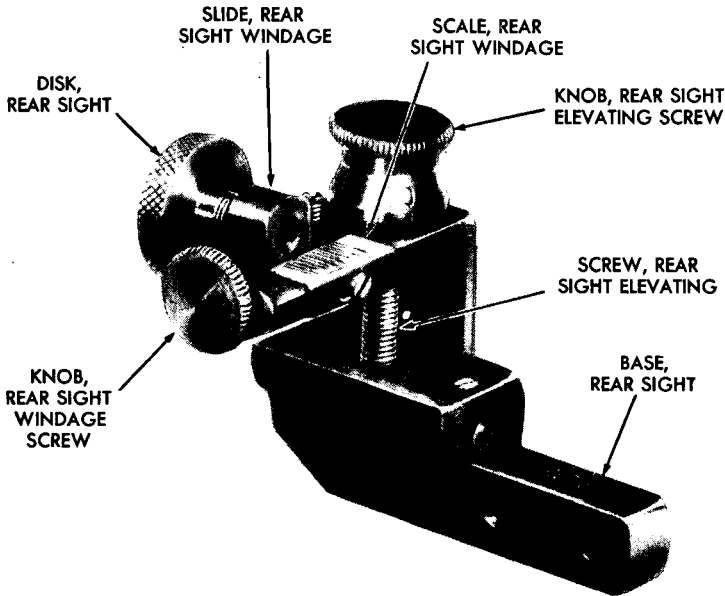

RA PD 81966

Figure 73 — Rear Sight Assembly of Winchester Rifle, Cal. .22, Model 75 — Right Front View

drilled and tapped to take the rear sight elevating screw. The rear sight base is longitudinally drilled for the rear sight lock bolt and spring.

c. The lock bolt has an elongated hole drilled in it, the front side of which is threaded to engage the elevating screw and slide. The forward portion of the lock bolt is undercut for the lock bolt spring. When the lock bolt is depressed against the spring pressure, the threads on the lock bolt are disengaged from the threads on the elevating screw allowing the removal of the elevating screw.

d. The rear sight elevating screw and knob are made in 1 piece (fig. 73). It is retained to the rear sight slide by a U-shaped rear sight elevating screw retainer. The knob has a knurled head with a scale beneath it. The scale is marked off in 12 graduations which correspond to the 12 slots or serrations on its under side. These 12 slots engage a raised portion of the rear sight elevating screw knob click. This click is made in a form of a round spring with 2 lugs which fit into a corresponding female machined surface on the top of the elevating slide. A raised portion on the click engages the slots or serrations in the bottom of the knob with the result that, when the elevating screw knob is turned, a distinct click is heard.

e. The rear sight elevating slide is an inverted L-shaped piece to which is assembled the rear sight elevating scale, the rear sight wind-

DESCRIPTION AND FUNCTIONING

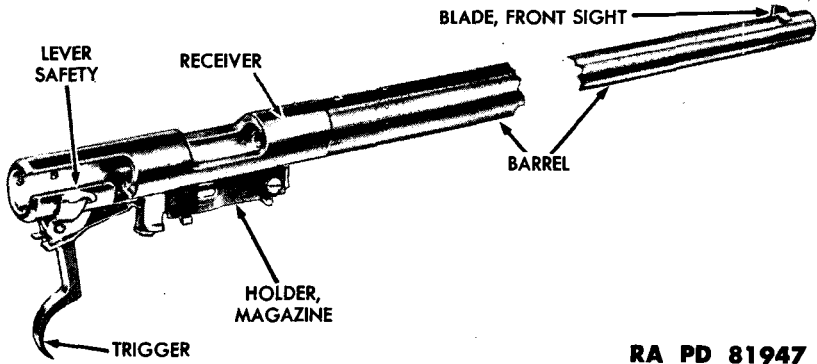

RA PD 81947

Figure 74 – Barrel and Receiver Group of Winchester Rifle, Cal. .22, Model 75

age slide, and the rear sight disk (fig. 72). The elevating scale is mounted on the side of the slide. The attaching hole in the center of the scale is elongated providing means of adjustment. The rear sight stop screw is mounted on the top of the slide. This screw acts as a stop for the slide and is adjustable. The top of the elevating slide is slotted to receive the rear sight windage slide and the screw and knob.

f. The windage slide is drilled and tapped to receive the rear sight windage screw and moves along on its threads when the screw is turned (fig. 73). At the end of the slot, the windage screw knob click is installed by means of two pins. The raised portion in the click engages the slots in the bottom of the knob so that when the knob is turned a distinct click is heard. The upper portion of the windage slide is drilled and tapped to receive the rear sight disk. Turning the windage knob moves the rear sight windage slide and disk to the right or left. A rear sight windage scale is mounted on the front of the top portion of the slide. Its attaching hole is elongated for adjustment by loosening its attaching screw.

32. BARREL AND RECEIVER GROUP.

a. The barrel and receiver group consists of the barrel group and receiver, trigger mechanism group, safety group, magazine holder group, and ejector (fig. 74).

b. **Barrel Group.** The barrel group includes the barrel, front sight, and stock stud. The barrel is 28.12 inches long and the rifling consists of six plain grooves 0.0025 inch deep. The twist is uniform right hand, one turn in 16 inches. The tenon at the rear is threaded for the purpose of securing the receiver to the barrel. Four tapped holes, two at the rear and two in the center of the barrel, are provided

CALIBER .22 RIFLES, ALL TYPES

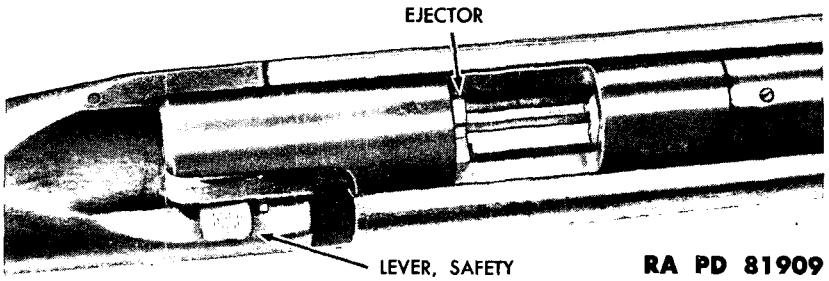

Figure 75 – Receiver Section of Winchester Rifle, Cal. .22, Model 75 – Bolt Removed – Top View

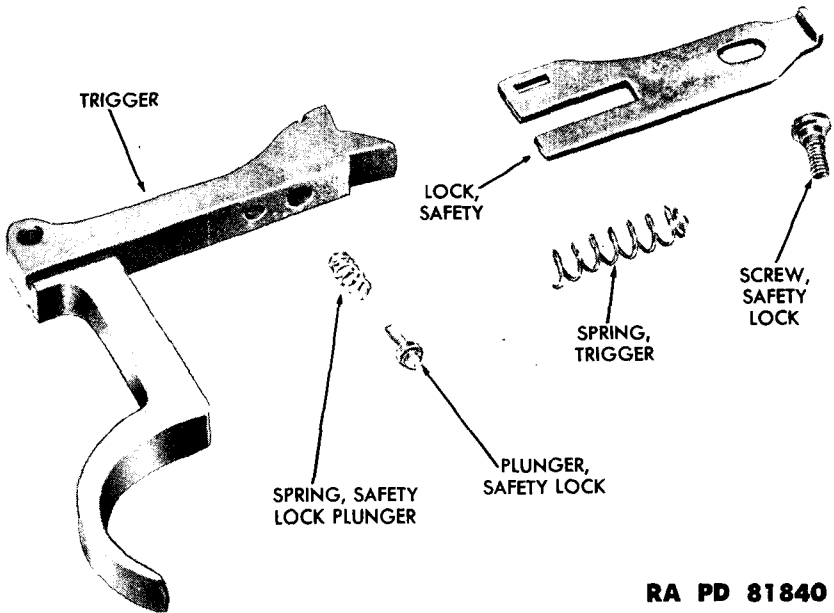
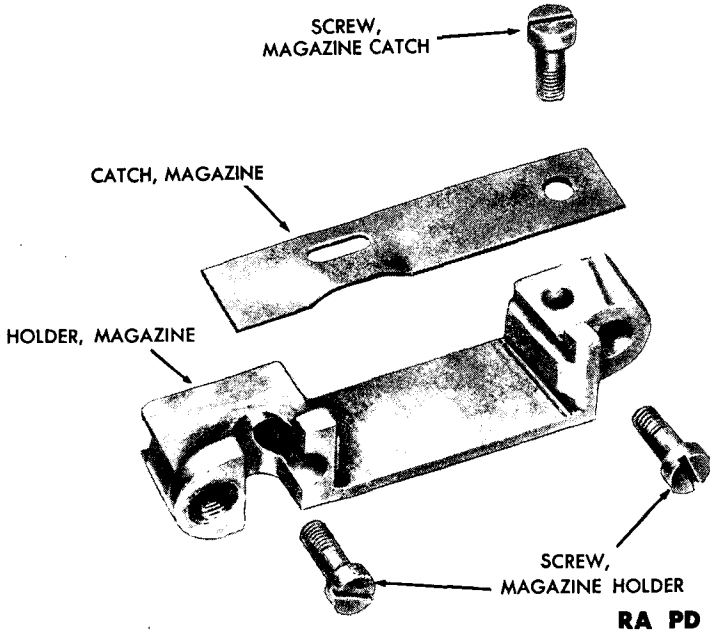

Figure 76 – Sear and Trigger and Safety Lock Groups of Winchester Rifle, Cal. .22, Model 75 – Exploded View

as a means of attaching a telescopic sight. The holes are plugged with screws. The breech of the barrel is recessed to receive the extractors. A dovetail is machined on the top front to receive the front sight. Another dovetail on the bottom at the receiver end secures the stock stud. The rear end of the barrel is mounted to the stock by a screw through the stock and into the stock stud. The front of the barrel is mounted by means of the barrel band, band screw, and barrel band screw bushing. The front sight is of the blade type and is a drive fit in the dovetail of the barrel.

DESCRIPTION AND FUNCTIONING



RA PD 81886

Figure 77 – Magazine Holder Group of Winchester Rifle, Cal. .22, Model 75 – Exploded View

c. Receiver. The receiver is chambered to receive the bolt and is slotted on one side to form a locking shoulder for the bolt handle (fig. 75). A cam on the top rear side of the slot together with the cam on the bottom front section of the bolt handle helps to force the bolt to its extreme forward position when the bolt handle is closed. Two tapped holes on the left side provide for the mounting of the rear sight. Suitable openings are provided in the bottom of the receiver for the magazine and sear end of the trigger. A dovetail is machined at the bottom to the rear to receive the trigger base. A slot in the rear of the receiver provides for the safety lever latch. A hole is provided on the right side for the safety lever stop pin. Just back of this pin, the words "FIRE" and "SAFE" are stamped.

d. Trigger Mechanism Group. The trigger mechanism group consists of the trigger, trigger base, trigger pin, trigger spring, and trigger spring adjusting screw (fig. 76). The trigger and sear are combined in one piece and mounted between the lugs of the trigger base, assembled to the receiver, by the trigger pin. Suitable holes are provided in the bottom of the trigger to provide for the safety lock screw and the safety lock plunger and plunger spring. The trigger spring and trigger spring adjusting screw are installed in the rear portion of the magazine holder. The spring bears against the under portion of the trigger and may be adjusted by means of the adjusting screw to alter the trigger pull.

CALIBER .22 RIFLES, ALL TYPES

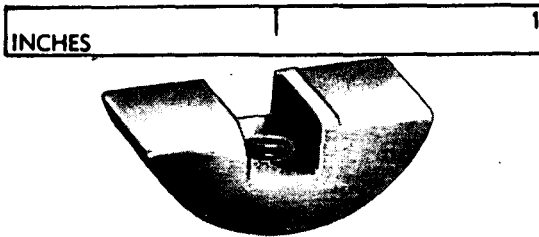

RA PD 81951

Figure 78 – Ejector of Winchester Rifle, Cal. .22, Model 75

e. **Safety Group.** The safety group includes the safety lock, the safety lock plunger, plunger spring, and safety lever. The safety lock is attached to the under side of the trigger-sear extension by means of the safety lock screw. The safety lock spring and plunger are located in a hole in the forward portion of the trigger and engage a detent in the safety lock. The safety lever is mounted on the trigger pin. This lever has two extensions at the lower end. One engages a slot in the safety lock and the other extends through the wall of the receiver and prevents the opening of the bolt when it is in the "safe" position by engaging the safety lock slot in the breech bolt cocking sleeve. At the same time, the safety lock is pushed forward and engages an undercut in the magazine holder to prevent trigger movement.

f. **Magazine Holder Group.** The magazine holder group includes the magazine holder and the magazine catch (fig. 77). The magazine holder is mounted on the bottom of the receiver by two magazine holder screws. The magazine catch is attached to the right side of the holder and is provided with a slot, which engages a lug on the side of the magazine. This lug is disengaged from the magazine catch by means of the magazine release plunger in the side of the stock.

g. **Ejector.** The ejector is mounted crosswise in the bottom of the receiver and is retained in place by means of the rear magazine holder screw (fig. 78). It is slotted in the center for the passage of the lug on the front of the breech bolt. A lug on the left side of the slot stops the backward movement of the cartridge and forces it from the left extractor hook and, with the help of the cam on the right side of the ejector, ejects the cartridge from the receiver.

33. STOCK GROUP.

a. The stock group includes the stock, magazine release group, barrel band, forearm adjustment base, forearm adjustment swivel bow assembly, stock swivel bow assembly (trigger), guard, and butt plate (fig. 79).

b. The stock is cut out at the top to receive the barrel, receiver, breech bolt handle, and rear sight.

DESCRIPTION AND FUNCTIONING

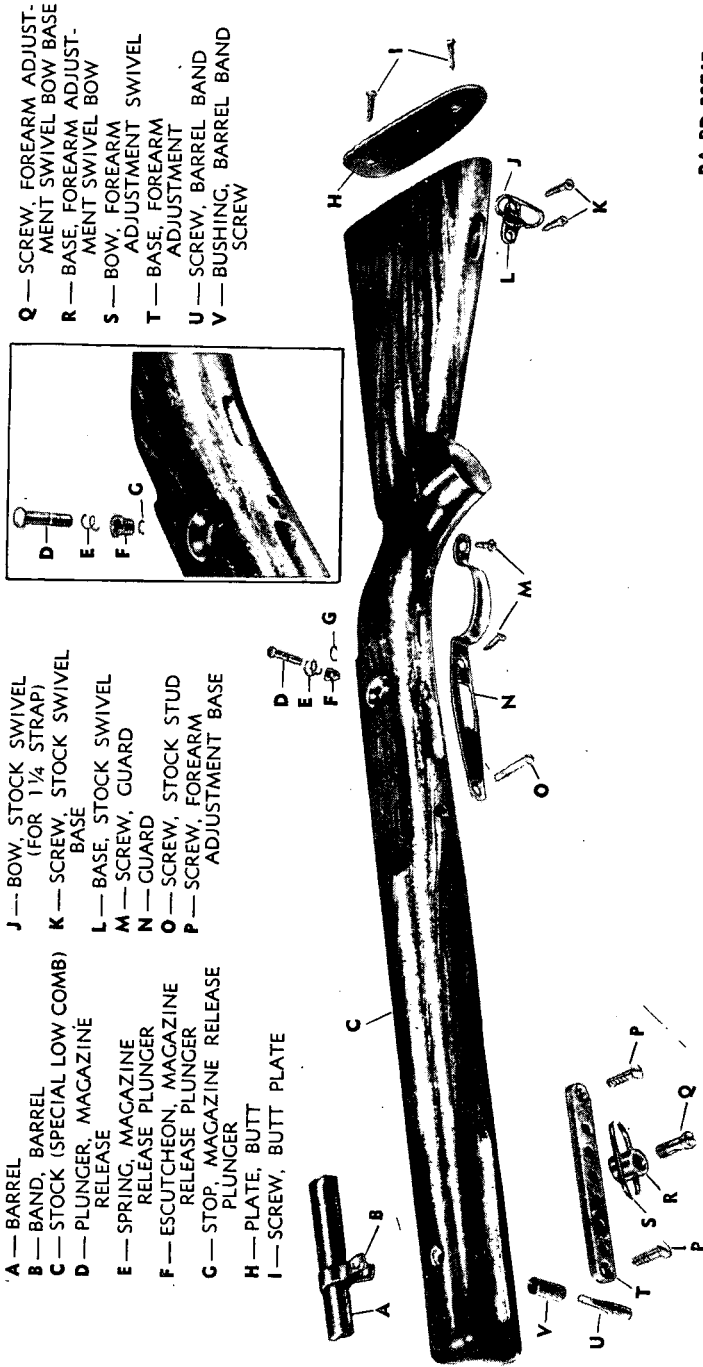

- A — BARREL
- B — BAND, BARREL
- C — STOCK (SPECIAL LOW COMB)
- D — PLUNGER, MAGAZINE RELEASE
- E — SPRING, MAGAZINE RELEASE PLUNGER
- F — ESCUTCHEON, MAGAZINE RELEASE PLUNGER
- G — STOP, MAGAZINE RELEASE PLUNGER
- H — PLATE, BUTT
- I — SCREW, BUTT PLATE
- J — BOW, STOCK SWIVEL (FOR 1/4 STRAP)
- K — SCREW, STOCK SWIVEL BASE
- L — BASE, STOCK SWIVEL
- M — SCREW, GUARD
- N — GUARD
- O — SCREW, STOCK STUD
- P — SCREW, FOREARM ADJUSTMENT BASE
- Q — SCREW, FOREARM ADJUSTMENT SWIVEL BOW BASE
- R — BASE, FOREARM ADJUSTMENT SWIVEL BOW
- S — BOW, FOREARM ADJUSTMENT SWIVEL
- T — BASE, FOREARM ADJUSTMENT
- U — SCREW, BARREL BAND
- V — BUSHING, BARREL BAND SCREW

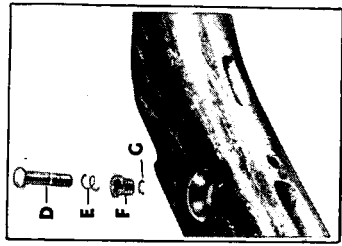

RA PD 22745

Figure 79 — Stock Group of Winchester Rifle, Cal. .22, Model 75 — Exploded View

CALIBER .22 RIFLES, ALL TYPES

c. The magazine release plunger and spring are mounted on the left side of the stock in the magazine release plunger escutcheon.

d. The barrel band fits over the barrel and into a slot provided in the front of the stock. The barrel band screw goes through the side of the stock and barrel band and screws into the barrel band screw bushing in the stock, securing the front end of the barrel to the stock.

e. The forearm adjustment base is mounted in a recess in the lower front portion of the stock and is secured in place with two wood screws. Six tapped holes are provided in the base for adjustment of handhold with relation to the sling. The forearm adjustment swivel bow assembly is attached to the forearm adjustment base by means of a screw.

f. The stock swivel bow assembly is mounted in a recess in the rear of the stock and secured by two wood screws.

g. The butt plate is attached to the rear of the stock by means of two screws.

h. The guard is attached to the stock by two wood screws and the stock stud screw which passes through the stock and threads into the stud to hold the barrel and receiver in the stock at the rear. It has openings for the magazine assembly and is formed to act as a guard for the trigger.

34. FUNCTIONING (fig. 65).

a. When the breech bolt handle is raised from the locking notch in the receiver, a cam surface formed in the rear position of the breech bolt cocking sleeve engages a lug on the firing pin and forces it to the rear. Rotation of the firing pin and breech bolt with the handle is prevented by the ejector which is secured in the bottom of the receiver well and engages the flattened portion of the breech bolt.

b. The sear is kept in contact with the firing pin by the trigger spring. When the firing pin is forced to the rear by the raising of the handle, the sear is pushed up to catch behind the sear lug of the firing pin.

c. As the bolt is further retracted, the two extractors which hold the cartridge against the face of the bolt pull the case from the firing chamber of the barrel. Just before the end of the retraction, the cartridge case strikes the ejector lug. As the bolt is further retracted, the cartridge case rim is forced from under the claw of the left extractor, is pivoted to the right around the right extractor hook, and thrown out of the receiver upward and to the right.

d. After the bolt and cartridge case have passed the magazine during retraction, the magazine spring and follower raises a cartridge partially out of the magazine where the rim is retained between the

DESCRIPTION AND FUNCTIONING

lips formed on the walls and the cartridge is held in an inclined position with the front of the bullet extending up and out of the magazine.

e. When the bolt is pushed forward to its closed position, the lug on the bottom of the bolt head pushes the cartridge forward until the rim is released at the end of the magazine lips and forced up under pressure of the magazine spring into the recess in the face of the bolt and under the extractors. As the bolt continues to move forward, the cartridge is seated in the chamber of the barrel and the sear is engaged in the sear lug on the firing pin. Turning the handle down locks the bolt with the firing pin cocked in the firing position.

f. When the trigger is pulled, the sear is disengaged from the firing pin sear lug. The firing pin spring (mainspring) then drives the striker end of the firing pin against the cartridge.

CALIBER .22 RIFLES, ALL TYPES

CHAPTER 3
OPERATION

35. LOADING THE MAGAZINE.

a. The magazines have a capacity of five cartridges, and are loaded by depressing the magazine follower and inserting one cartridge at a time. With its rim toward the back, the rim of the cartridge is pressed down into the slots on each side of the magazine and the cartridge then pushed back under the lips to the back of the tube (fig. 80). The insertion of each succeeding cartridge then pushes the first ones down toward the bottom of the magazine.

36. LOADING THE RIFLE.

a. The loaded magazine is inserted into the rifle through the magazine opening in the bottom of the receiver just forward of the trigger guard (fig. 81) and pushed upward until locked in place. To fully load the rifle, the bolt should be drawn entirely to the rear and then closed and locked. This action cocks the rifle and pushes the top cartridge from the magazine into the chamber. The safety should be placed at "safe" before loading the rifle.

NOTE A: An extra cartridge, making a total of six, can be used by opening the bolt, placing a cartridge fully in the chamber, and closing the bolt before inserting the loaded magazine. The rifle is completely cocked when the bolt is returned to the closed and locked position.

NOTE B: The bolts of the U.S. and Winchester rifles cannot be unlocked nor retracted with the safety in the "safe" position. Therefore, the safety lock of the U.S. rifles should be placed in the vertical (center) position, and the safety of the Winchester rifle in the "fire" position when placing a cartridge in the chamber by hand or loading a cartridge from the magazine into the chamber. The safeties should be placed at the "safe" position *immediately* after the rifle is thus fully loaded. The trigger should not be touched while loading or shifting the safety.

37. SETTING THE SAFETY.

a. The safety locks of the U.S. Rifles M1 and M2 are operated by turning the thumbpiece to the extreme left position when ready to fire (fig. 82). When the thumbpiece is in the center or vertical position, the trigger cannot be pulled, but the bolt handle can be raised and retracted. When the thumbpiece is in the "safe" position at the extreme right, the trigger cannot be pulled and the bolt handle cannot be raised.

OPERATION

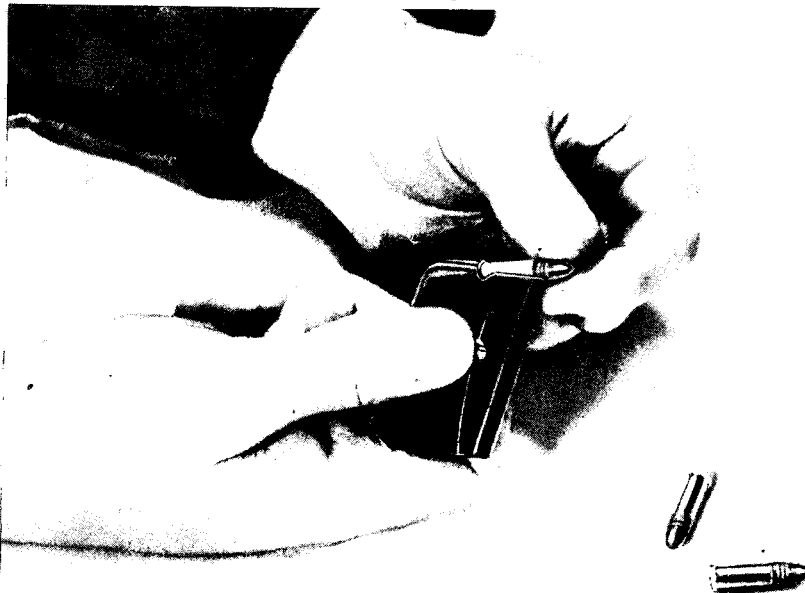

RA PD 81847

Figure 80 – Loading the Magazine

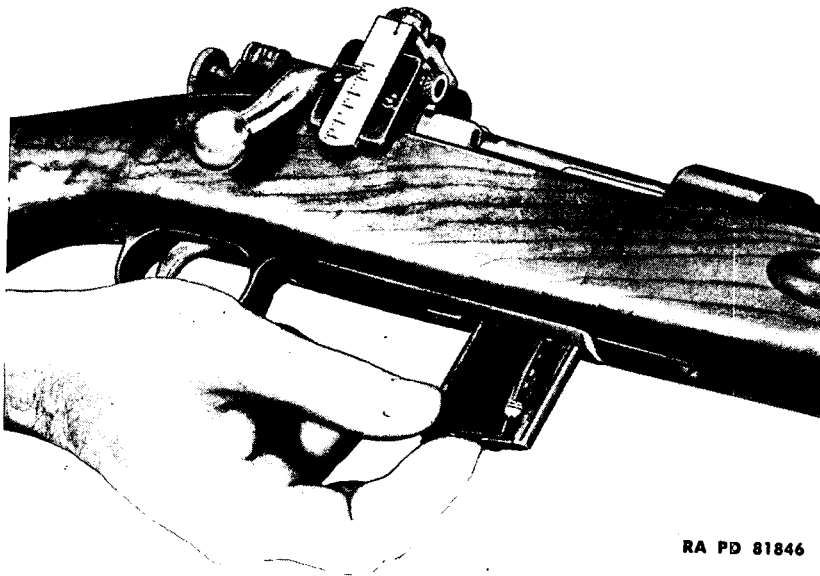

RA PD 81846

Figure 81 – Inserting Magazine in the Rifle

CALIBER .22 RIFLES, ALL TYPES

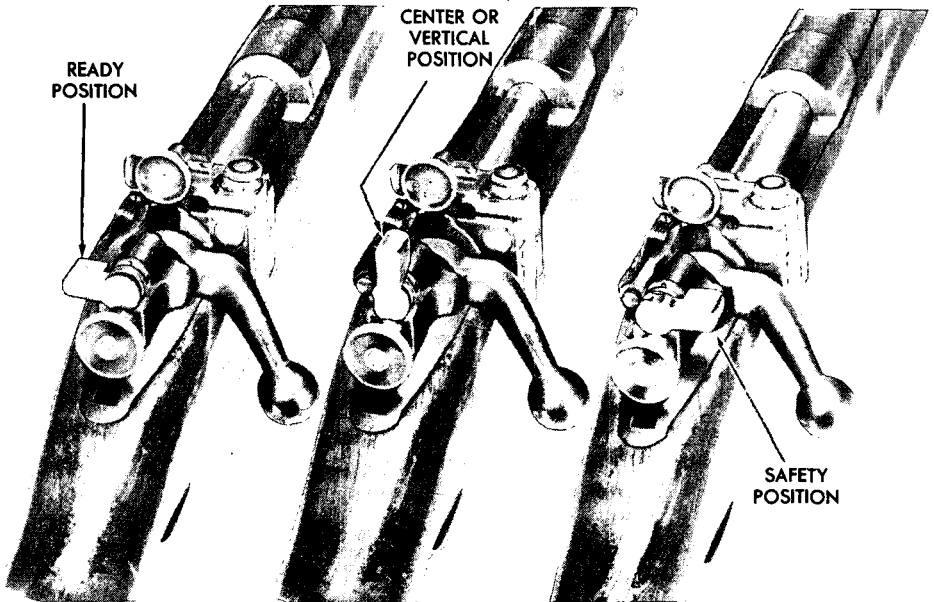

RA PD 81961

Figure 82 – Safety Lock of U.S. Rifle, Cal. .22, M2 – Showing Ready, Neutral (Center), and Safe (Safety) Positions

b. In the Remington Rifle, cal. .22, Model 513T, the safety on the right of the receiver is operated by pushing the safety lever forward (red dot showing) for “firing” position, or to the rear for “safe” position.

c. The safety of the Stevens Rifle, cal. .22, Model 416-2, is operated by pushing the thumbpiece on the right of the receiver to the rear in order to fire, and fully forward for “safe” position.

d. The safety lock of the Winchester Rifle, cal. .22, Model 75, is operated by pushing the safety lever, on the right side of the receiver, forward for firing and fully to the rear for “safe” position, until the word “SAFE” is exposed.

38. FIRING AND RECOCKING.

a. The rifles are fired by setting the safety lock at *ready*, and drawing the finger piece of the trigger to the rear. The rifles fire once when the trigger is squeezed.

b. The rifles are recocked, the fired cartridge ejected, and a new one pushed into the chamber by lifting the bolt handle, drawing it fully to the rear, and returning it to closed and locked position.

39. REAR SIGHT SETTING.

a. Rear Sights.

(1) **GENERAL.** The rear sights of the rifles covered in this manual

OPERATION

are provided with elevating and windage screws for shifting the

aperture (or like part) for elevation and windage settings. These screws are furnished with knobs which, when turned, are retained in position by click springs or retaining balls seating in notches in the face of the knobs. The seating of the click spring or balls in the notches can be plainly heard or felt as the knobs are turned. The relation between the pitch of the screw threads and the notches in the knobs is such that each notch corresponds to a shift of the aperture vertically or laterally measured in minutes of angle. Each minute of angle corresponds to a shift in point of impact of the bullet on the target in inches, varying with the range or distance from the target. These fractional shifts of the knobs are called "clicks." In the rifles covered herein, each click corresponds to either a $\frac{1}{4}$ - or $\frac{1}{2}$ -minute change in angle of sight; such changes correspond to a $\frac{1}{4}$ - or $\frac{1}{2}$ -inch shift of the point of impact of the bullet on the target at 100 yards. This shift varies with the distance; as the range is doubled or halved the amount of shift of point of impact is doubled or halved. Thus in a sight having $\frac{1}{4}$ -minute click graduations, the point of impact will be shifted one-sixteenth inch at 25 yards, one-eighth inch at 50 yards, one-fourth inch at 100 yards, one-half inch at 200 yards, etc. Likewise in a sight having $\frac{1}{2}$ -minute click graduations, the point of impact will be shifted one-eighth inch at 25 yards, one-fourth inch at 50 yards, one-half inch at 100 yards, etc., in the same ratio. Turning the elevating screw knob shifts the point of impact vertically, and turning the windage screw knob shifts the point of impact laterally. The sights are usually adjusted at manufacture but to make sure they are correct they should be checked on the range.

(2) U.S. RIFLES, CAL. .22, M1 AND M2. These rifles are furnished with the Lyman 48C receiver sight with $\frac{1}{2}$ -minute clicks. The elevating scale of this sight is marked for ranges of 25, 50, 75, 100, and 125 yards. Each yardage division is subdivided into 5 parts, each subdivision representing 5 yards of range. The elevating screw knob is marked in 10 divisions, each division corresponds to 1 click which is plainly heard or felt as the knob is turned. Each division or click represents one-half minute of angle, and will shift the point of impact of the bullet as explained in step (1), above. The windage scale is graduated in minutes of angle, the central position only being marked by a "O." The windage screw knob also has 10 clicks to a full revolution but the divisions are not marked on the knob. Both the (elevating scale) pointer screwed to the sight

CALIBER .22 RIFLES, ALL TYPES

nished with the Redfield 75RT rear sight with $\frac{1}{4}$ -minute clicks. The elevating slide is graduated and marked in minutes of angle. Each division represents 3 minutes, and every 5 divisions are marked to represent 15, 30, 45, and 60 minutes of angle respectively. The right side of the slide is blank and can be marked for ranges in yards when determined. The elevating screw knob has 12 click divisions, each of which corresponds to one-fourth minute of angle. Thus, a full revolution of the knob corresponds to 3 minutes of angle or 1 division on the slide. The windage index plate likewise is divided into 3-minute divisions with a "0" stamped at the central point. The windage screw knob corresponds in divisions and clicks to the elevating screw. The windage index plate and elevating (slide) plate are adjustable for setting when the zero of the rifle is determined.

NOTE: One click of elevating or windage knob represents a shift of one-sixteenth inch at 25 yards.

(4) **STEVENS RIFLE, CAL. .22, MODEL 416-2.** This rifle is furnished with a Stevens (No. 106) rear sight, with $\frac{1}{2}$ -minute clicks. This sight differs somewhat from other sights covered herein, in that the elevating slide moves vertically in the windage slide, rather than the windage slide moving laterally in the elevating slide. The face of the windage slide is marked in 10 divisions, each of which represents 6 minutes of angle. There is no alinement mark on the elevating slide, nor on the base to align the windage slide. Such marks should be made when the sight has been adjusted for minimum range and zero windage. There are no marks on the elevating or windage screw knobs. Each knob is divided into 6 click divisions, each division representing one-half minute of angle. Two full revolutions of the knobs or 12 clicks, represent 6 minutes of angle or, in the case of the elevating knob, 1 division on the elevating scale on the windage slide.

NOTE: One click of elevating or windage knob represents a shift of one-eighth inch at 25 yards.

(5) **WINCHESTER RIFLE, CAL. .22, MODEL 75.** This rifle is furnished with a Lyman 57E rear sight with $\frac{1}{4}$ -minute clicks. The elevating scale is attached to the elevating slide and marked for 50, 100, 150, and 200 yards. The windage scale is attached to the top of the elevating slide and marked in minutes of angle. Both scales are adjustable. The elevating screw knob has 12 divisions, each of which corresponds to one-fourth minute of angle. Thus a full revolution of the knob represents a change of 3 minutes of angle. The windage screw knob is similarly divided into 12 clicks but is not so marked.

NOTE: One click of elevating or windage knob represents a shift of one-eighth inch at 50 yards.

b. Zeroing the Sights.

(1) The sights of each rifle should be checked to ascertain the

OPERATION

basic or "zero" setting for the particular rifle. For accuracy, such zero settings are best done at short range. The approximate zero setting of the sights is explained below. When such setting is determined and noted, the rifle should be checked at various yardages and any variations from computed settings noted. In sighting-in these rifles, a large target should be used with a cross in the center, and the rifle fired from a rest. Such a target will register the first few shots which may be out of line, and clearly indicate the point of impact vertically or laterally from center. All sighting-in should be done on a safe range and on a day without any wind. As short ranges are preferable for such zero settings, 25 yards is taken, which means 25 yards from the muzzle of the rifle to the target. As the minimum setting of the sight on the Winchester rifle is 50 yards, this distance is taken as minimum yardage for this rifle. As the point of impact of each bullet will vary somewhat, the center of the group should be considered.

(2) As the sights of the four rifles covered herein are basically alike, the method of zeroing the sights as explained below will apply generally. However, as the design and nomenclature of like parts vary somewhat, instructions should be considered as applying to like parts of each sight. To set the sights for minimum range and zero windage, take position 25 yards from the target (50 yd for Winchester) and proceed as follows:

(a) Screw the elevating slide, or like part, down as far as it will go by turning the elevating knob. If yardage is marked on the scale, the slide may be set at proper yardage for a test shot.

(b) Set the aperture, or like part, as near the center (bore line) as possible by turning the windage knob.

(c) Fire a few shots and correct for windage to center the point of bullet impact laterally, by turning the windage knob in the proper direction. Moving the aperture, or like part, to the right will shift the point of bullet impact on the target to the right, and vice versa. When the point of impact is centered laterally set the windage scale plate, or like part, so that the "0" aligns with the indicating line on the aperture. In the case of the Stevens rifle, mark the windage slide and sight base to indicate the central position.

(d) Correct for elevation in like manner to center the point of bullet impact vertically, by turning the elevating knob in the proper direction. Moving the elevating slide, or like part, up, raises the point of bullet impact on the target, and vice versa. When point of bullet impact is centered vertically, mark the position of the elevating slide with regard to the pointer or indicating line, according to the rifle in question, as follows:

1. *U.S. Rifles M1 and M2.* Set pointer to 25-yard mark on slide.
2. *Remington Model 513T.* Set pointer of the plate at "0," and mark 25 on the slide opposite "0," to indicate yardage.

CALIBER .22 RIFLES, ALL TYPES

3. *Stevens Model 416-2.* Mark elevating slide to correspond with "0" stamped on the scale on the windage slide.

4. *Winchester Model 75.* Set elevation scale so that 50-yard mark is opposite the "0" indicating mark on sight base.

(e) Check sight settings at various yardages and note any variations from computed settings.

NOTE: A range table for the U.S. rifles, which have ½-minute clicks is given in paragraph 73 f.

CHAPTER 4

MALFUNCTIONS AND CORRECTIONS

40. GENERAL.

a. A malfunction is an improper or incomplete action of some part of the rifle or ammunition, which prevents the proper functioning of the rifle as a unit. A malfunction may be due to a broken, damaged or faulty part, improper assembly or cleaning, or faulty ammunition. Examples of a malfunction are: failure to extract a fired cartridge case, or failure of the bolt to close and lock properly.

CAUTION: In case of a misfire, the bolt should not be unlocked for about 15 seconds as failure to fire may be due to a hangfire. A hangfire is caused by delayed ignition of the powder in the cartridge.

b. Repair by the using arms, is limited to cleaning, removal of burs, and such minor repairs or adjustments as lie within its scope with the tools and spare parts provided. If a malfunction cannot be readily corrected by such means, the rifle should be turned over to a responsible ordnance unit for inspection and repair. No attempt should be made by the using arms to correct head space. Trigger pull should not be altered except by such adjustments as are provided, as in the case of the trigger adjusting mechanisms of the Remington and Winchester rifles. Each adjustment should only be made under the supervision of an officer or the chief mechanic. Sear or trigger should never be stoned except by experienced ordnance personnel.

c. The following malfunctions and corrections apply, in general to all caliber .22 rifles covered in this manual.

41. MALFUNCTIONS AND CORRECTIONS.

a. Failure To Fire.

Cause		Correction
Magazine and chamber empty.	Load.	
Broken firing pin.	Replace.	
Failure to put bolt handle fully down.	Recock.	
b. Misfire.		
Defective cartridge.		
Weak mainspring.	Replace.	
Heavy grease on firing pin or in bolt.	Clean.	
Worn or broken firing pin.	Replace.	
Firing pin binding in bolt head.	Replace.	
Firing pin rod binding in bolt head.	Replace or repair.	
Bolt not completely locked.	Reload and lock.	

CALIBER .22 RIFLES, ALL TYPES

c. Hangfire.

Cause

Correction

Defective ammunition.
Light blow of firing pin.

Replace mainspring.

d. Blowback.

Ruptured cartridge.

e. Split Case.

Defective case.

f. Stretched Case.

Excessive head space.

Repair.

g. Ruptured Case.

Defective metal or excessive head space.

Repair.

h. Failure To Extract.

Faulty extractor.
Dirty or rough chamber.
Defective case.

Replace.
Clean or repair.

i. Failure To Eject.

Bur on ejector tip.
Loose extractor due to defective extractor, spring, or pin.
Extractor dropping cartridge upon ejector.

Remove bur.
Replace defective part.

j. Failure To Feed From Magazine.

Deformed magazine lips.
Weak follower spring.
Tight extractor.
Interference of ejector.

Replace magazine.
Replace magazine.
Replace or repair.
Replace.

k. Failure To Feed Into Chamber.

Damaged cartridge.
Magazine not seated properly.

Seat magazine firmly. Replace magazine retaining spring if necessary.

Magazine retaining notch worn allowing misplacement.

Replace magazine.

Dented magazine.

Replace magazine.

Deformed magazine lips.

Replace magazine.

CHAPTER 5

CARE AND PRESERVATION

42. GENERAL.

a. The following instructions for the care and preservation apply to all caliber .22 rifles covered in this manual.

b. Proper functioning and accuracy depend largely upon care, cleaning, and lubrication. The rifle should be checked daily for cleanliness and lubrication.

c. It is a fact that a highly polished steel surface rusts much less easily than one which is roughened; also, that a rifle bore which is pitted fouls much more rapidly than one which is smooth. Every effort therefore should be made to prevent the formation of pits which are merely enlarged rust spots and which not only affect the accuracy of the rifle but increase the labor of cleaning. When the bore of a rifle becomes badly pitted, the weapon will shoot inaccurately and lead excessively. No amount of cleaning will restore such a bore. The rifle should be turned in to an ordnance establishment to have a new barrel fitted. Such a condition of the bore is always caused by neglect.

d. In cleaning the rifle, great care should be exercised not to injure the chamber as this is a most critical part of the rifle barrel. Particularly is this true of the caliber .22. If the chamber is burred or scratched, it will not only affect seating and extraction but it probably will cause the bullet to be so deformed that all semblance of accuracy is lost. Always let the cleaning rod turn with the grooves of the rifling when forcing it through the barrel.

43. CLEANING WHEN NO FIRING IS DONE.

a. **General.** During periods when the rifle is not used for firing, it should be inspected daily. The weapon will be wiped thoroughly clean and the film of oil on all metal surfaces renewed every 5 days, unless there is evidence of rusting which will necessitate more frequent application.

b. **Stock and Other Wood Parts.** Wipe off the exterior of the rifle with a dry cloth to remove dampness, dirt, and perspiration. About once a month, apply OIL, linseed, raw, to the wood with a cloth. The surplus oil should be wiped off and the stock polished with a clean dry cloth or the palm of the hand. Care should be exerted to see that the linseed oil is kept away from the operating parts of the rifle as it will harden and prevent functioning. Linseed oil should not be used on varnished stocks.

c. **Metal Surfaces.** To clean screwheads and crevices, use a small cleaning brush or a stick. To clean metal surfaces, including the bolt

CALIBER .22 RIFLES, ALL TYPES

mechanism and magazines, wipe with a dry cloth to remove moisture, perspiration, and dirt, then wipe with a wiping cloth moistened with OIL, lubricating, preservative, special. This protective film of oil should be maintained at all times. To clean the outer surfaces of the rifle, wipe off dirt with a slightly oiled cloth, wipe dry with a soft clean one, and then oil lightly as above.

d. **Bore.** The bore of the rifle will always be cleaned by inserting a cleaning rod into the breech end to avoid possible injury to the rifling at the muzzle. The bolt must be removed for this purpose. The Cleaning Rod M1 should be used. To clean the bore, assemble a patch, cut (canton flannel) to the cleaning rod and insert the rod into the bore at the breech end. Move the cleaning rod and patch forward and backward several times through the bore and replace with a clean patch. Be sure the patch goes all the way through the bore before the direction is reversed. This will prevent the patch and rod from becoming stuck in the bore. After the bore has been thoroughly cleaned, saturate a patch with OIL, lubricating, preservative, special, and push it through the bore to apply a light film of oil. When issue patches are not available, patches should be cut to $\frac{3}{4}$ to $\frac{7}{8}$ inch square to permit their passage through the bore without bending the cleaning rod.

NOTE: The chamber must be cleaned as thoroughly as the bore. A rough chamber may cause cartridges to stick.

e. After cleaning and protecting the rifle as described above, place it in the rifle rack without any covering and without a plug in the muzzle. Muzzle covers, gun covers, rack covers, and plugs must not be used. They cause sweating and promote rust. When barracks are being swept, rifle racks should be covered to protect the rifles from dust. These covers must be removed immediately after the rooms have been swept, and dust has settled.

f. **Oiling.** Excessive oiling is a waste of oil and results in a collection of dirt which causes friction and wear. In weather below freezing, care should be taken to use oil very sparingly, after careful cleaning of all parts. For care of the rifle in extremely cold weather, refer to chapter II.

g. **Rust-preventive.** For use of rust-preventives refer to paragraph 80.

h. **Gun Sling M1907.** The gun sling may be washed with water and castile soap. When dry, OIL, neat's-foot, may be applied with a piece of cloth or sponge. Wipe off excess oil and rub well into the leather. Do not use an excessive amount of oil as it will take a long time to dry and may mark clothing.

44. CLEANING PREPARATORY TO FIRING.

a. The following procedure will be observed to assure efficient functioning of the rifle:

CARE AND PRESERVATION

- (1) Disassemble main groups (chap. 6).
- (2) Thoroughly clean the bore and chamber (par. 42).
- (3) Thoroughly clean and lightly oil all metal parts, especially the bolt mechanism parts. Use OIL, lubricating, preservative, special.
- (4) Be sure the following parts are well lubricated:
 - (a) Bolt lugs (locking and operating).
 - (b) Bolt guides.
 - (c) Locking cam on bolt.
- (5) Reassemble the main groups (chap. 6).
- (6) Remove all dust with a dry, clean wiping cloth and then rub the rifle with a slightly oiled cloth or patch.
- (7) Wipe the bore and chamber clean with a clean, dry, patch.

45. CLEANING DURING FIRING.

a. Clean the chamber at reasonable intervals during extended firing to facilitate extraction of cartridge cases and to prevent pitting and rusting.

b. In general, it should not be necessary to disassemble the gun during firing for cleaning. However, if the mechanism becomes very dirty and functions sluggishly, disassemble the rifle into its groups and clean as instructed in paragraph 44.

46. CLEANING AFTER FIRING.

a. Rifles should be cleaned not later than the evening of the day on which they are fired, preferably immediately after cessation of firing, and should be inspected and cleaned every day for at least 3 days following cessation of firing. Complete cleaning should be done with the groups disassembled.

b. Bore and Chamber.

(1) Proper care of the bore consists in removing fouling resulting from firing to obtain a chemically clean surface and coating this surface with a film of oil to prevent rusting. Fouling which results from firing is caused by either products of combustion of the powder and primer composition, or small flakes of lead that occasionally appear in the bore. The former is sometimes acid in its reaction and therefore highly corrosive. If of this character, it will induce rust and must be removed. Even with noncorrosive ammunition, it is best to remove fouling. Lead flakes in themselves are inactive, but they may cover powder fouling and unless removed, may prevent the action of cleaning agents. The flakes can be readily and completely pushed out of the bore by using the method described in step (3), below. Should this procedure not suffice, dip the brass wire brush in the bore cleaning solution and, using the cleaning rod, carefully push the brush completely through the bore about five times.

NOTE: If the brush is threaded to the cleaning rod, pass rod

CALIBER .22 RIFLES, ALL TYPES

through bore, then attach brush and *pull* through. This procedure will prevent brush from bending during insertion.

(2) The bore should be thoroughly cleaned with CLEANER, rifle bore. This cleaner is a combination solvent and preservative issued for use by troops in cleaning small arms. When CLEANER, rifle bore, is not available, the bore should be cleaned with hot water and soap solution or (one-fourth lb of castile or issue soap per gal of water), or SODA ASH, and warm water solution (1½ spoonfuls per pt of water), hot water alone, or in the absence of these, cold water. After cleaning with SODA ASH, or soap and water solution, the bore and chamber should be thoroughly rinsed with clean water. They should then be thoroughly dried and oiled. To avoid possible injury to the rifling at the muzzle, rifle bores will be cleaned from the chamber end, the bolt being removed for this purpose.

(3) To use CLEANER, rifle bore, insert a clean patch in the slot in the cleaning rod and saturate it with cleaner. Push patch back and forth through the bore several times, taking care that all points of the bore are cleaned from muzzle to chamber. Be sure the patch goes all the way through the bore before the direction is reversed. This will prevent the patch and rod from becoming stuck in the bore. While the bore is wet, a clean brush should be pulled through three or four times to remove any hardened particles in the bore. Run several patches saturated with cleaner entirely through the bore, removing them from the muzzle end, then wipe the cleaning rod dry, and using dry clean patches, thoroughly dry the bore. Clean the chamber in the same general manner using a patch wrapped around a stick if necessary. To use hot soap and water solution, SODA ASH, and water solution, or water alone, follow the same procedure. Care should be taken to avoid wetting the stock or other parts of the rifle. Examine the bore and chamber carefully for cleanliness. If they are not free from all residue, repeat the cleaning process. Rinse the bore with clean water and dry thoroughly before oiling.

(4) Oil the bore and chamber thoroughly, using the cleaning rod and clean, dry patches saturated with OIL, lubricating, preservative, special.

47. CLEANING RIFLES RECEIVED FROM STORAGE.

a. Rifles received from storage may be completely covered with COMPOUND, rust-preventive, light. Use SOLVENT, dry-cleaning, to remove all traces of the compound or oil, taking particular care that all recesses in which springs or plungers operate are cleaned thoroughly. The solvent is generally applied with cloth swabs to large parts and as a bath for small parts.

b. After using the solvent, make sure it is completely removed from all parts by wiping thoroughly, allowing the parts to dry, and then

CARE AND PRESERVATION

again wiping with a clean, dry cloth. The bore and chamber of the barrel must be thoroughly cleaned.

NOTE: To avoid leaving finger marks, which are ordinarily acid and induce corrosion, gloves should be worn by persons handling parts after such cleaning. **SOLVENT**, dry-cleaning, will attack and discolor rubber.

c. All surfaces having been thoroughly cleaned and dried, they should then be protected *immediately* with a thin film of oil applied with a cloth, as cleaning solvent removes every trace of oil or grease and metal is susceptible to quick rusting.

d. The stock should be wiped off with a rag which has been dipped in linseed oil. (Linseed oil should not be used on varnished stocks.)

CAUTION: *Failure to clean the firing pin and main spring, and the recesses in the bolt in which they operate, may result in gun failure at normal temperatures, and will certainly result in serious malfunctions if the rifles are used in low temperatures, as rust-preventive compound and other foreign matter will cause the oil to congeal or frost on the mechanism.*

48. LUBRICATION.

a. Immediately after cleaning, all metallic bearing and contact surfaces will be thoroughly lubricated with **OIL**, lubricating, preservative, special. A protective film of oil should be maintained at all times. Lubrication should be applied lightly, as too much oil collects grit and foreign matter, which will cause undue wear and possible malfunctioning of the rifle.

b. Any part that may appear hard to move, generally can be freed by use of a little oil. The best method of applying oil is rubbing with a piece of cotton cloth upon which a few drops of oil have been placed, thereby avoiding the use of an unnecessary amount. This method will also serve for cams and bearings, which should always be kept oiled. Particularly, each day before the rifle is fired, the rear surface of the bolt handle locking lug, the surface of the receiver against which it locks, and the sleeve bearing between bolt head and bolt handle should be wiped dry and clean, and then wiped with an oily cloth. If these surfaces are not kept clean and lubricated at all times, it will cause frictional wear which, in time, will result in increase of head space to a point detrimental to the accuracy and safety of the weapon. When the rifle is used in a dusty or sandy locality, lubrication should be kept at a minimum and parts cleaned frequently, as oil causes dust to stick, forming an abrasive paste which is conducive to undue wear. The interior bore of the bolt handle and bolt head and the firing mechanism assembly, however, should never have an excess of oil on them, as this would interfere with perfect ignition, and be detrimental to the best accuracy. These parts should be wiped clean

CALIBER .22 RIFLES, ALL TYPES

and dry at frequent intervals, and should then be lightly wiped with a very slightly oiled cloth so that they will have just a slight "shine" of oil. As the bore of the rifle, when properly cared for, will successfully withstand firing of more than 100,000 rounds of ammunition without impairment of accuracy, proper care and lubrication of the breech mechanism are very important in order that there may be no wear from friction during the life of the barrel.

NOTE: The procedure outlined in subparagraph **b**, above applies specifically to the U.S. rifles, but also applies in general to like parts of the commercial rifles.

CHAPTER 6

DISASSEMBLY AND ASSEMBLY

49. GENERAL.

a. Disassembly and assembly by the using arms are confined to removal and installation of the major groups for the purpose of replacement or cleaning. These five groups are the bolt group or assembly, magazine assembly, barrel and receiver group, rear sight group or assembly, and stock group (par. 6 c).

b. Removed groups should be placed on a clean flat surface, preferably wood, to prevent abrasion of parts. Care should be taken to avoid loss of pins, screws, and other small parts.

NOTE: Full disassembly and assembly is limited to ordnance personnel, and covered in TM 9-1280.

50. U.S. RIFLES, CAL. .22, M1 AND M2 (figs. 83 and 84).

a. Bolt With Firing Mechanism Assembly.

(1) REMOVAL. Turn the ejector stop downward to its lower notch or to an almost horizontal position. Raise the bolt handle and draw the bolt back and out of the receiver (figs. 85 and 86).

NOTE: If the bolt is to be disassembled, the rifle should be cocked and the safety lock turned to its vertical position before removal.

(2) INSTALLATION. With the ejector stop in the middle notch or horizontal position, push the bolt with the locking lug up into the receiver. Turn the ejector stop up into its seat on the receiver. Push the bolt handle down (figs. 85 and 86).

CAUTION: The rifle is now cocked and ready for firing.

(3) DISASSEMBLY OF M2 BOLT. The bolt should not be disassembled except for replacement of firing pin assembly or extractor which are furnished as organizational spare parts. To disassemble proceed as follows:

(a) Hold bolt mechanism in left hand; press bolt sleeve lock in with thumb of right hand; turn bolt sleeve to left sufficiently to release latch lug on bolt head from locking lug on bolt handle; remove bolt head. Hold bolt head in left hand, pressing extractor against a bench, and with right hand push point of a small screwdriver under hook of extractor; force downward and up and remove extractor from bolt head.

(b) Remove firing mechanism assembly from bolt handle by unscrewing to left; grasp firing mechanism assembly in left hand, firing pin point down; turn safety lock into center position and lock cocking piece; with thumb and forefinger on bolt sleeve and fingers holding mainspring, press firing pin point against some object, not hard enough to injure it, and unscrew firing pin nut, allowing mainspring to release slowly. The bolt sleeve and safety lock assembly, cocking piece, mainspring, and firing pin can then be separated.

CALIBER .22 RIFLES, ALL TYPES

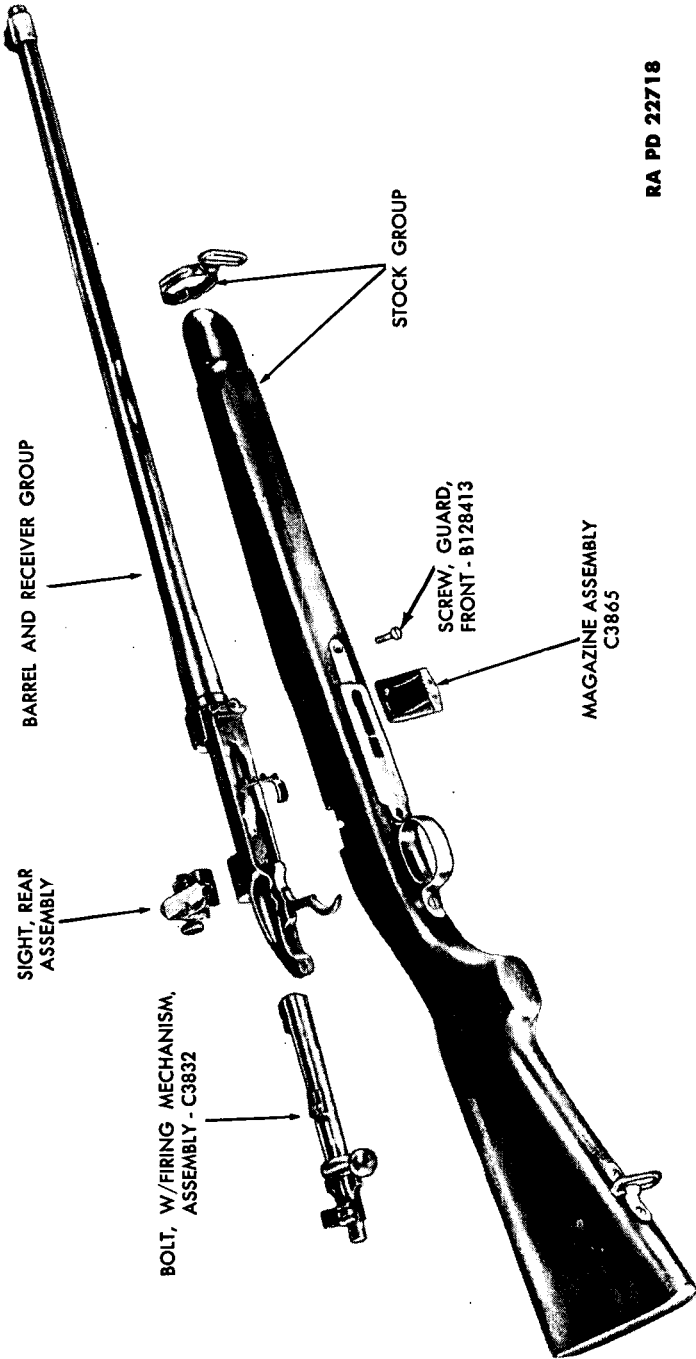

RA PD 22718

Figure 83 — U.S. Rifle, Cal. .22, M1 — Groups Removed

DISASSEMBLY AND ASSEMBLY

RA PD 22722

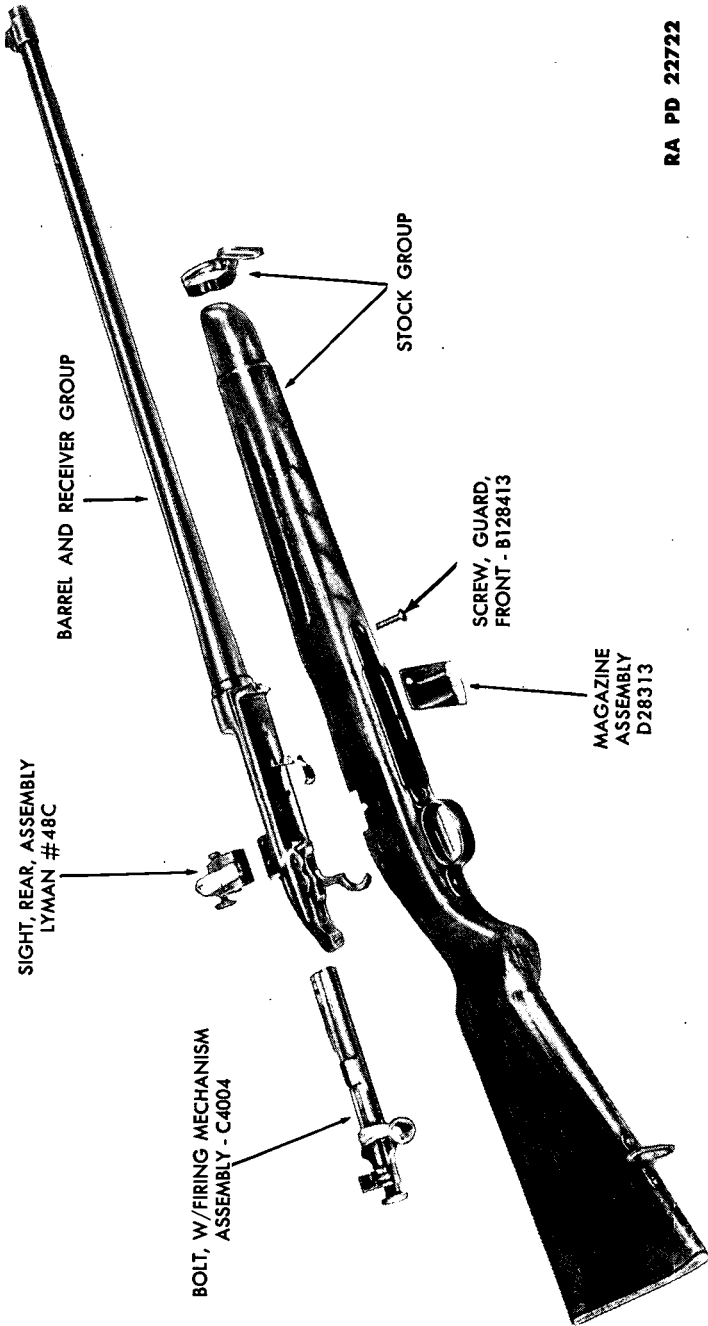
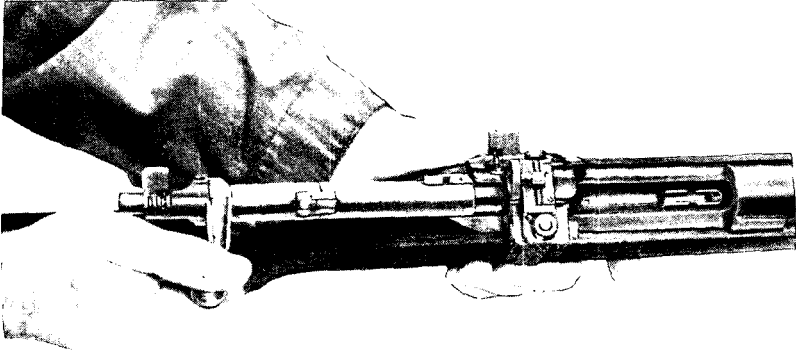

Figure 84 — U.S. Rifle, Cal. .22, M2 — Groups Removed

CALIBER .22 RIFLES, ALL TYPES



RA PD 81848

Figure 85 – Removing Bolt From U.S. Rifle, Cal. .22, M1

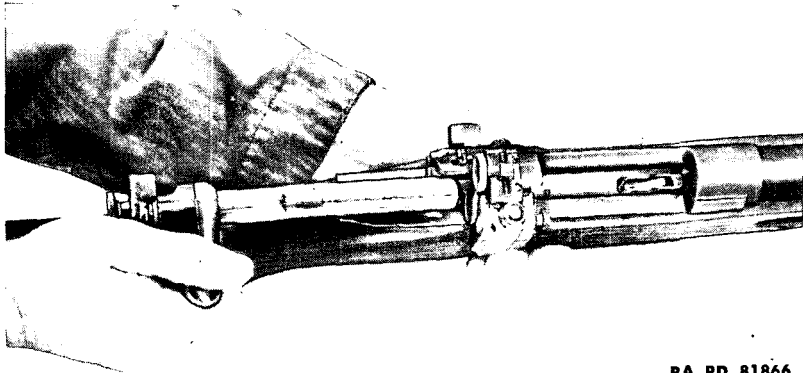

RA PD 81866

Figure 86 – Removing Bolt From U.S. Rifle, Cal. .22, M2

(4) ASSEMBLY OF M2 BOLT.

(a) Assemble bolt sleeve and cocking piece with safety lock in center position; then assemble mainspring and bolt sleeve with cocking piece on firing pin; compress mainspring and screw firing pin nut on end of firing pin.

(b) Screw firing mechanism assembly into bolt handle until bolt sleeve lock engages its slot in bolt handle. Press firing pin point against some object which forces cocking piece backward and allows safety lock to be turned to vertical position. Press bolt sleeve lock in and turn bolt sleeve to left about one-quarter turn; insert bolt handle into bolt head as far as it will go; then turn bolt sleeve to right until bolt sleeve lock engages its slot in bolt handle.

(c) Hold rear end of bolt mechanism in left hand with extractor slot in bolt head up; place extractor in slot; grasp front end of bolt mechanism with right hand, thumb on extractor; place end of extractor

DISASSEMBLY AND ASSEMBLY

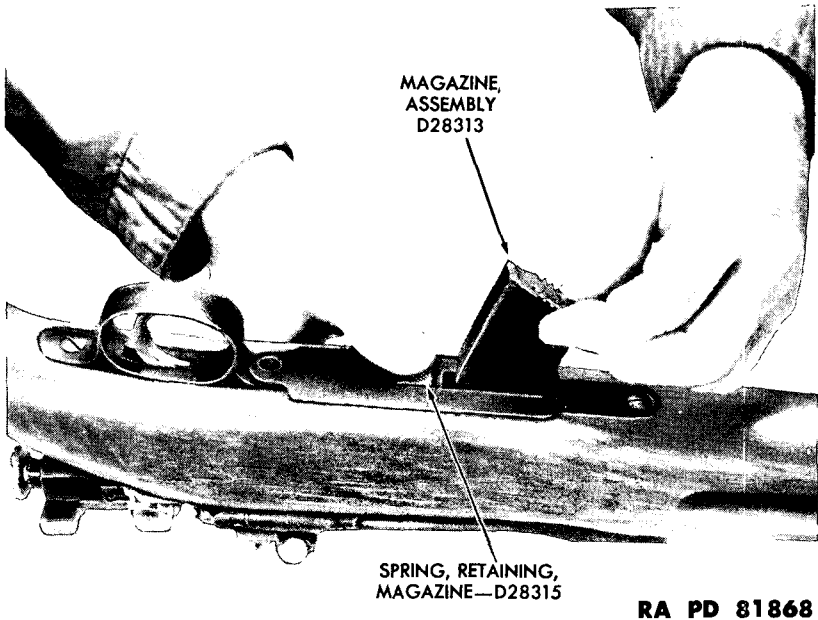

RA PD 81868

Figure 87 – Removing Magazine From U.S. Rifle, Cal. .22, M2

against some firm object; depress extractor with thumb of right hand and force extractor into place in bolt head.

b. Magazine Assembly:

(1) **REMOVAL.** With the rifle supported in the right hand, press in on the thumbpiece of the magazine retaining spring with the right forefinger. Pull out the magazine with the left hand (fig. 87).

(2) **INSTALLATION.** Holding the rounded portion of the magazine to the front of the rifle, slide it into its recess until it seats into position with a click.

c. Rear Sight Group.

(1) **REMOVAL.** Unscrew the rear sight lock bolt as far as possible, press it in, and at the same time, lift the rear sight slide up sufficiently to expose the short rear sight mounting screw underneath the left side of the slide (fig. 88). Remove this short rear sight mounting screw (fig. 89). Remove the other mounting screw and remove the sight.

(2) **INSTALLATION.** Place the rear sight base in position on the receiver with the rear sight slide removed to expose the hole for the short rear sight mounting screw. Install the short and long rear sight mounting screws (fig. 89). Press in on the rear sight lock bolt and push the rear sight slide down into position.

(3) **INSTALLATION OF ANTI-AIRCRAFT REAR SIGHT APERTURE.** When the caliber .22 rifle is used for anti-aircraft training, it is neces-

CALIBER .22 RIFLES, ALL TYPES



RA PD 81895

Figure 88 — Removing Rear Sight Elevating Slide From U.S. Rifle, Cal. .22, M2

sary that the rear sight aperture be removed and the antiaircraft rear sight aperture (fig. 90) be substituted in its place.

(a) To remove the rear sight aperture, unscrew the rear sight lock bolt as far as possible, press it in, and at the same time lift out the rear sight slide. With a jeweler's screwdriver, unscrew the rear sight windage screw knob set screw part way (fig. 91). This allows the rear sight windage screw knob to be removed. Lift off the rear sight windage click spring. Unscrew the two cap screws and lift off the rear sight windage cap. Slide out the rear sight aperture and windage screw. Unscrew the rear sight windage screw from the rear sight aperture.

(b) To install the antiaircraft rear sight aperture, place the antiaircraft rear sight aperture on the rear sight slide and screw the rear sight windage screw all the way in. Put the rear sight windage cap in place, with the flat side down. Screw in the two rear sight windage cap screws. Place the rear sight windage click spring over the heads of the two rear sight windage cap screws, having the notch on the

DISASSEMBLY AND ASSEMBLY

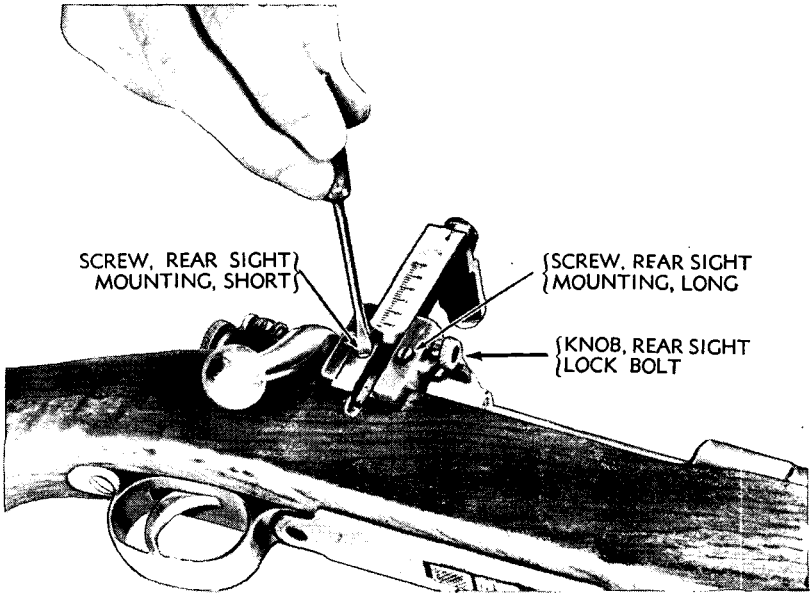

RA PD 22723

Figure 89 – Removing Rear Sight From U.S. Rifle, Cal. .22, M2

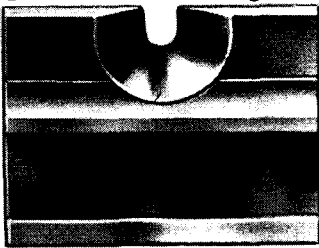

BACK VIEW

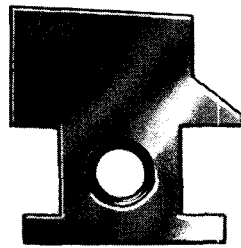

SIDE VIEW

RA PD 81988

Figure 90 – Antiaircraft Rear Sight Aperture for U.S. Rifle, Cal. .22, M1 and M2

lower side. Note the position of the hole in the end of the rear sight windage screw, and place the rear sight windage screw knob on the rear sight windage screw so that the rear sight windage screw knob set screw will be in line with this hole. Press in on the rear sight windage screw knob and screw in the rear sight windage screw knob set screw (fig. 91). There should be no movement of the rear sight windage screw knob on the rear sight windage screw. Press in on the rear sight lock bolt knob and push the rear sight slide into its place in the rear sight base. Screw up the rear sight lock bolt knob.

CALIBER .22 RIFLES, ALL TYPES

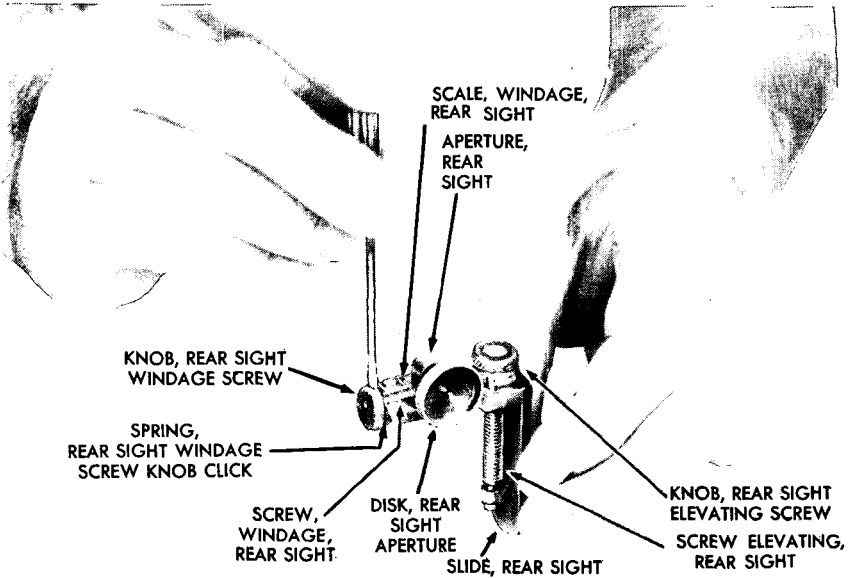

RA PD 22730

Figure 91 — Removing Rear Sight Windage Screw Knob From Rear Sight of U.S. Rifle, Cal. .22, M2

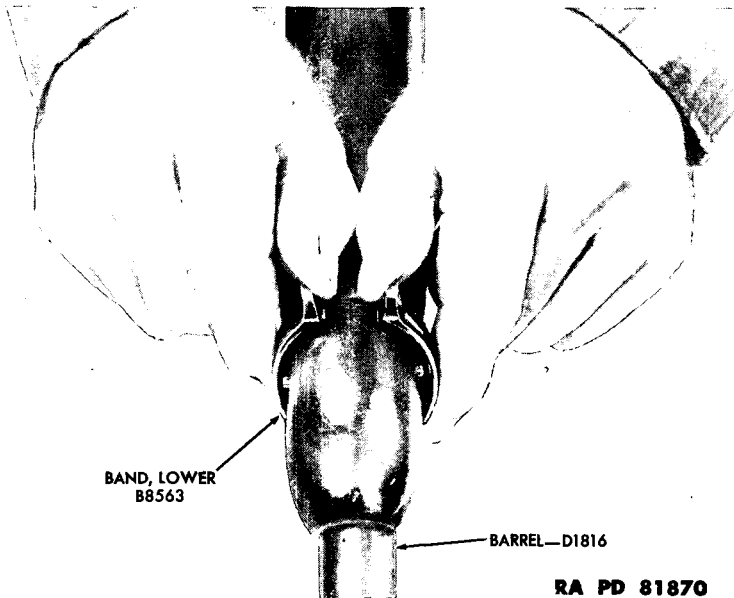

RA PD 81870

Figure 92 — Removing Lower Band From U.S. Rifle, Cal. .22, M2

DISASSEMBLY AND ASSEMBLY

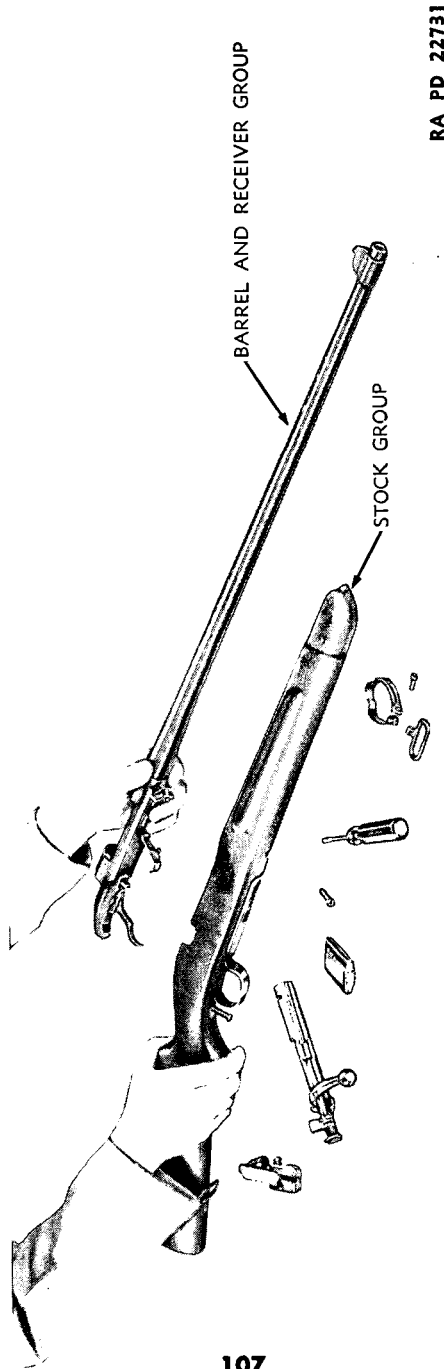

Figure 93 — Removing Barrel and Receiver Group From Stock Group of U.S. Rifle, Cal. .22, M2

CALIBER .22 RIFLES, ALL TYPES

d. Barrel and Receiver Group.

(1) **REMOVAL.** Loosen the lower band screw in the lower band swivel, spread the band apart far enough to clear the lower band pin in the stock, and slide the lower band from the stock and off the front of the barrel (fig. 92). Remove the front and rear guard screws. Lift the barrel and receiver group from the stock (fig. 93). The trigger guard group may then be removed from the stock.

(2) **INSTALLATION.**

(a) Place the barrel and receiver group in position in the stock (fig. 93).

CAUTION: If the rear sight has not been removed, keep the stock, as well as the barrel and receiver, flat against the bench so as not to damage the rear sight by hitting it against the bench.

(b) Place the trigger guard group in position. Insert and tighten the front and rear guard screws. Slide the lower band over the barrel and stock with the open end of the small "U" stamped on the band, toward the front. Place the lower band swivel between the two ears of the band and install the lower band screw.

51. REMINGTON RIFLE, CAL. .22, MODEL 513T (fig. 94).

a. Bolt Group.

(1) **REMOVAL.** With safety forward, raise the bolt handle and draw the bolt back as far as it will go. Depress the trigger and pull the bolt back and out of the receiver (fig. 95).

(2) **INSTALLATION.** Slide the bolt into the receiver as far as it will go. (If bolt has become uncocked, place it in a padded vise and cock it by raising the bolt handle.) Depress the trigger until the bolt handle enters the slot in the receiver (fig. 95). Release the trigger and slide the bolt to its extreme forward position. Push the bolt handle down.

CAUTION: Be sure to release the trigger before sliding the bolt to its extreme forward position since it is cocked and might fire if pushed forward fast while the trigger is depressed.

b. Magazine Assembly.

(1) **REMOVAL.** Press the magazine lock back towards the trigger and pull out the magazine assembly (fig. 96).

(2) **INSTALLATION.** Holding the convex side of the magazine toward the rear of the rifle, slide the magazine into its recess until it seats in its proper position.

c. Rear Sight Assembly.

(1) **REMOVAL.** Unscrew the rear sight base mounting screw and the sight will come away from the rear sight base mounting block (fig. 97). Remove the two screws attaching the rear sight base mounting block to the receiver, and remove the block.

DISASSEMBLY AND ASSEMBLY

RA PD 22716

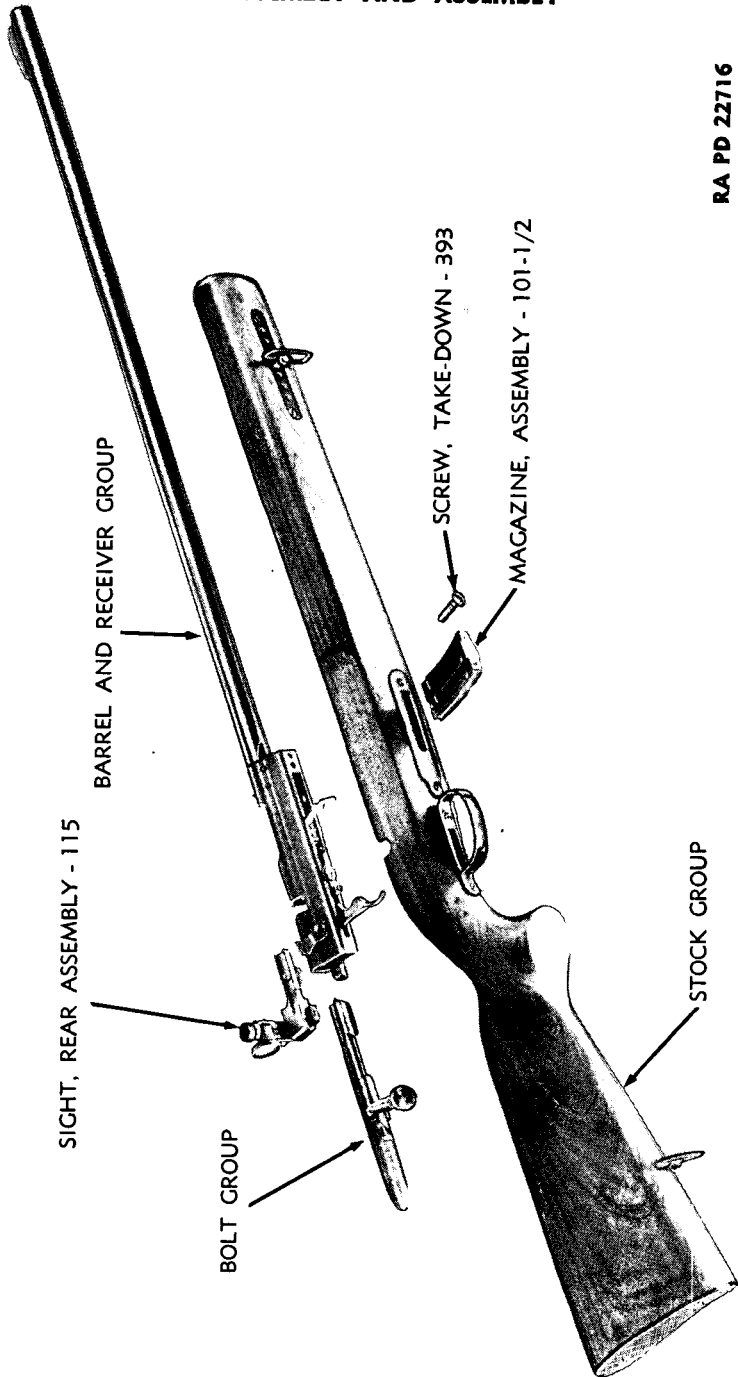
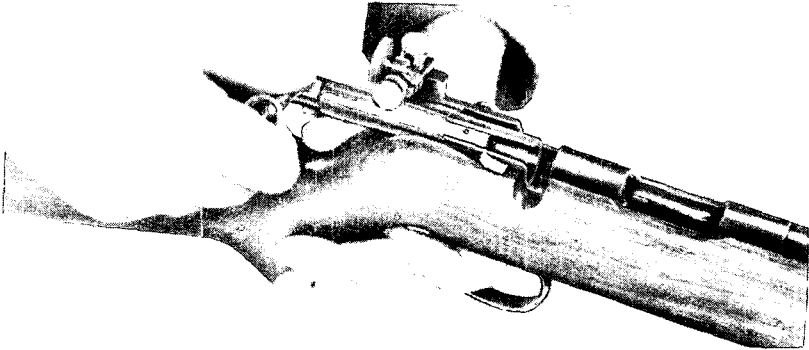

Figure 94 — Remington Rifle, Cal. .22, Model 513T — Groups Removed

CALIBER .22 RIFLES, ALL TYPES



RA PD 81892 /

**Figure 95 – Removing Bolt From Remington Rifle,
Cal. .22, Model 513T**

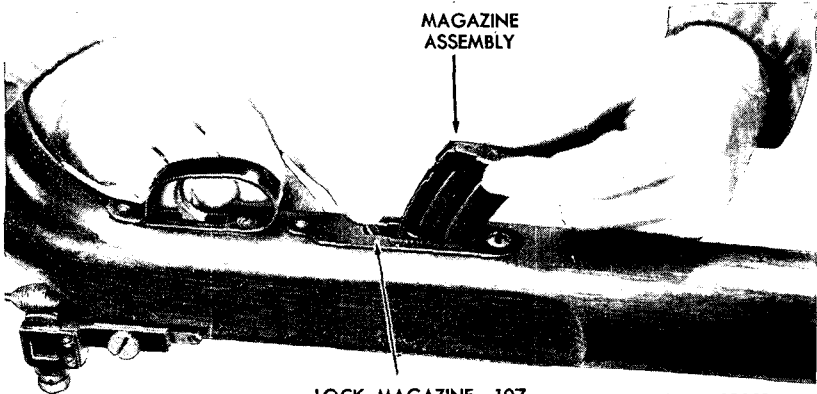

LOCK, MAGAZINE—107

RA PD 81865

**Figure 96 – Removing Magazine From Remington Rifle,
Cal. .22, Model 513T**

(2) **INSTALLATION.** Install the rear sight base mounting block with its two mounting screws to the receiver. Install the rear sight assembly on the rear sight base mounting block and secure in place with the rear sight base mounting screw (fig. 97)

d. Barrel and Receiver Group.

(1) **REMOVAL.** Remove the take-down screw from the front end of the magazine guide plate. Remove the barrel and receiver group from the stock (fig. 98).

(2) **INSTALLATION.**

(a) Place the barrel and receiver group in the top of the stock (fig. 98).

CAUTION: If the rear sight has not been removed, keep the stock,

DISASSEMBLY AND ASSEMBLY

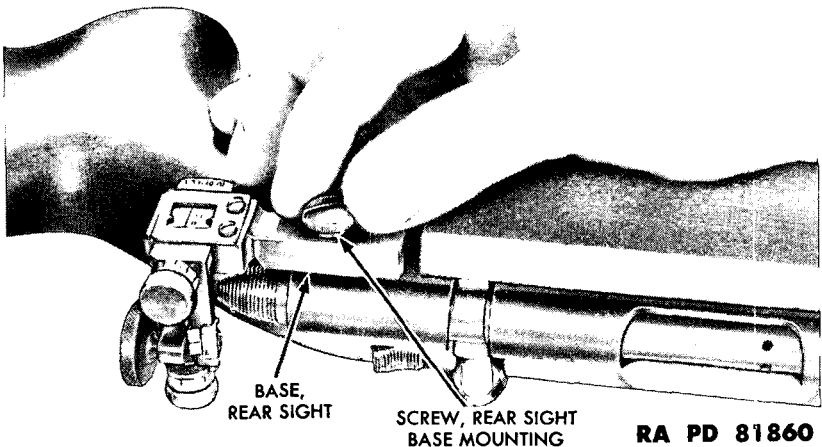

**Figure 97 – Removing Rear Sight From Remington Rifle,
Cal. .22, Model 513T**

as well as the barrel and receiver, flat against the bench so as not to damage the rear sight by hitting it against the bench.

(b) Insert the take-down screw in its proper position in the front of the magazine guide plate and tighten.

52. STEVENS RIFLE, CAL. .22, MODEL 416-2 (fig. 99).

a. Bolt Assembly.

(1) **REMOVAL.** With safety pushed to rear, raise the bolt handle and draw the bolt back as far as it will go. Depress the trigger and pull the bolt back and out of the receiver (fig. 100).

(2) **INSTALLATION.** Slide the bolt assembly into the receiver as far as it will go. (If the bolt has become uncocked, place it in a padded vise and cock it by raising the bolt handle.) Depress the trigger until the bolt handle enters the slot in the receiver (fig. 100). Release the trigger and slide the bolt to its extreme forward position. Push the bolt handle down.

CAUTION: Be sure to release the trigger before sliding the bolt to its extreme forward position since it is cocked and might fire if pushed forward fast while the trigger is depressed.

b. Magazine Assembly.

(1) **REMOVAL.** Compress the magazine retainer on the bottom of the receiver and pull the magazine out (fig. 101).

CALIBER .22 RIFLES, ALL TYPES

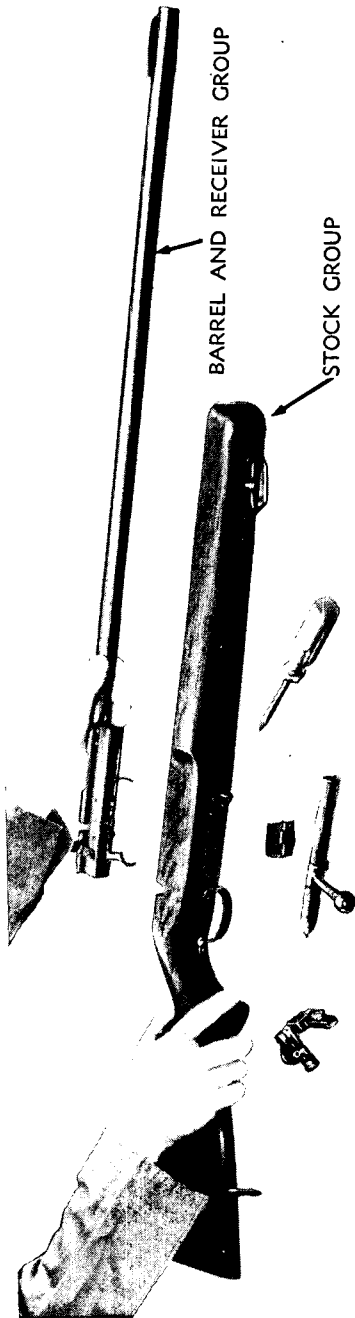
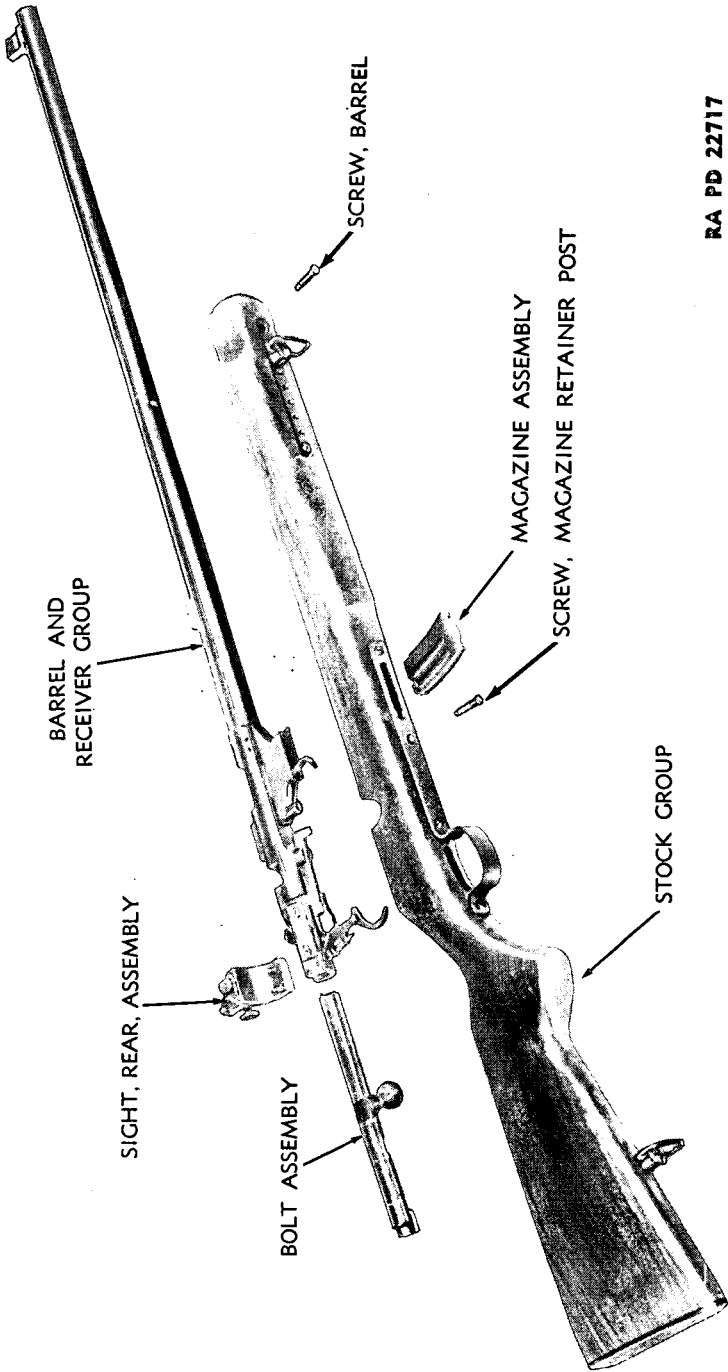

Figure 98 — Removing Barrel and Receiver Group From Stock Group of Remington Rifle, Cal. .22, Model 513T

DISASSEMBLY AND ASSEMBLY



RA PD 22717

Figure 99 — Stevens Rifle, Cal. .22, Model 416-2 — Groups Removed

CALIBER .22 RIFLES, ALL TYPES

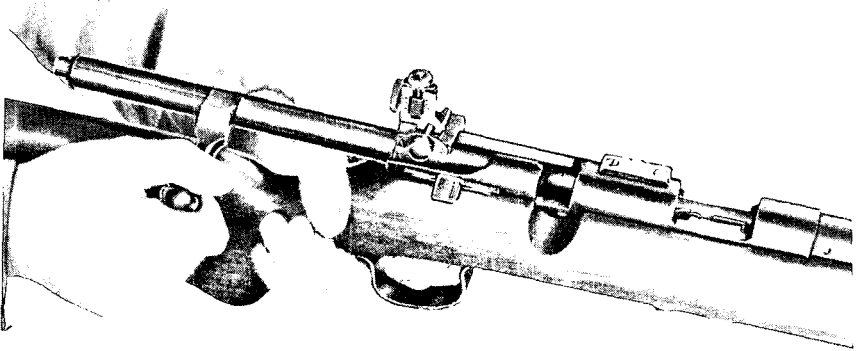

RA PD 81891

**Figure 100 – Removing Bolt From Stevens Rifle,
Cal. .22, Model 416-2**

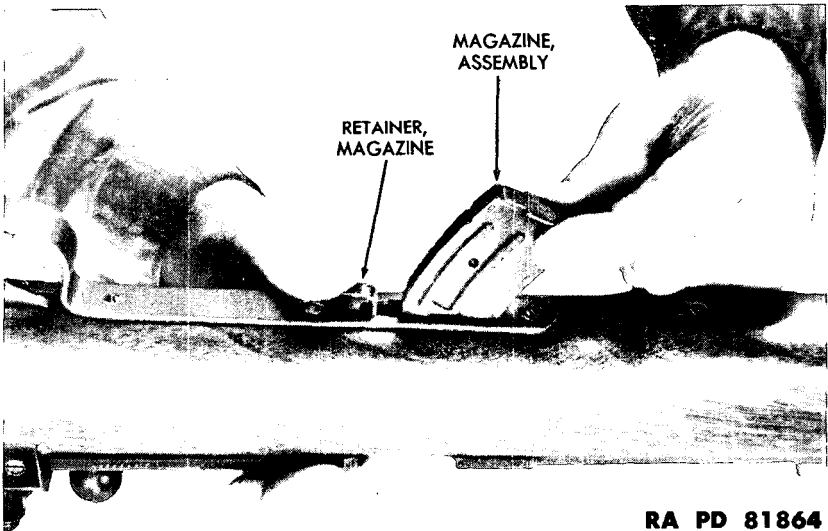

RA PD 81864

**Figure 101 – Removing Magazine From Stevens Rifle,
Cal. .22, Model 416-2**

(2) **INSTALLATION.** Holding the convex portion of the magazine assembly towards the rear of the rifle, slide it into its recess until it seats and is locked in its proper position.

c. Rear Sight Group Assembly.

(1) **REMOVAL.** Remove the two rear sight base screws and remove the rear sight from the receiver (fig. 102).

(2) **INSTALLATION.** Place the rear sight assembly in its proper position on the receiver and secure in place with the two rear sight base screws (fig. 102).

DISASSEMBLY AND ASSEMBLY

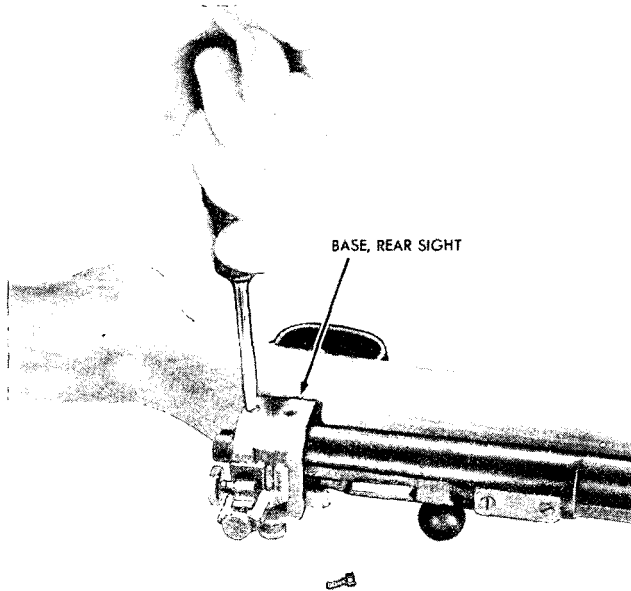

RA PD 81867

Figure 102 — Removing Rear Sight From Stevens Rifle, Cal. .22, Model 416-2

d. Barrel and Receiver Group.

(1) **REMOVAL.** Remove the barrel screw in the front swivel plate, and the magazine retainer post screw from center of guard. The barrel and receiver assembly can now be removed from the stock (fig. 103).

(2) **INSTALLATION.**

(a) Place the barrel and receiver assembly in place in the stock (fig. 103).

CAUTION: If the rear sight has not been removed, keep the stock, as well as the barrel and receiver, flat against the bench so as not to damage the rear sight by hitting it against the bench.

(b) Insert the barrel screw in the front swivel plate and insert the magazine retainer post screw in proper position and tighten.

53. WINCHESTER RIFLE, CAL. .22, MODEL 75 (fig. 104).

a. Breech Bolt Assembly.

(1) **REMOVAL.** With safety forward, raise the bolt handle and draw the bolt back as far as it will go. Depress the trigger, and pull the bolt back and out of the receiver (fig. 105).

(2) **INSTALLATION.** Slide the bolt into the receiver as far as it will go. (If the bolt has become uncocked, place it in a padded vise

CALIBER .22 RIFLES, ALL TYPES

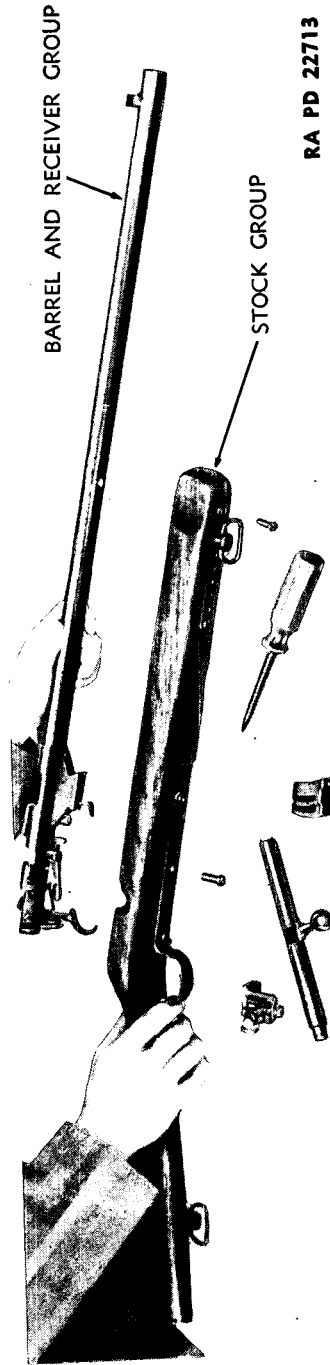
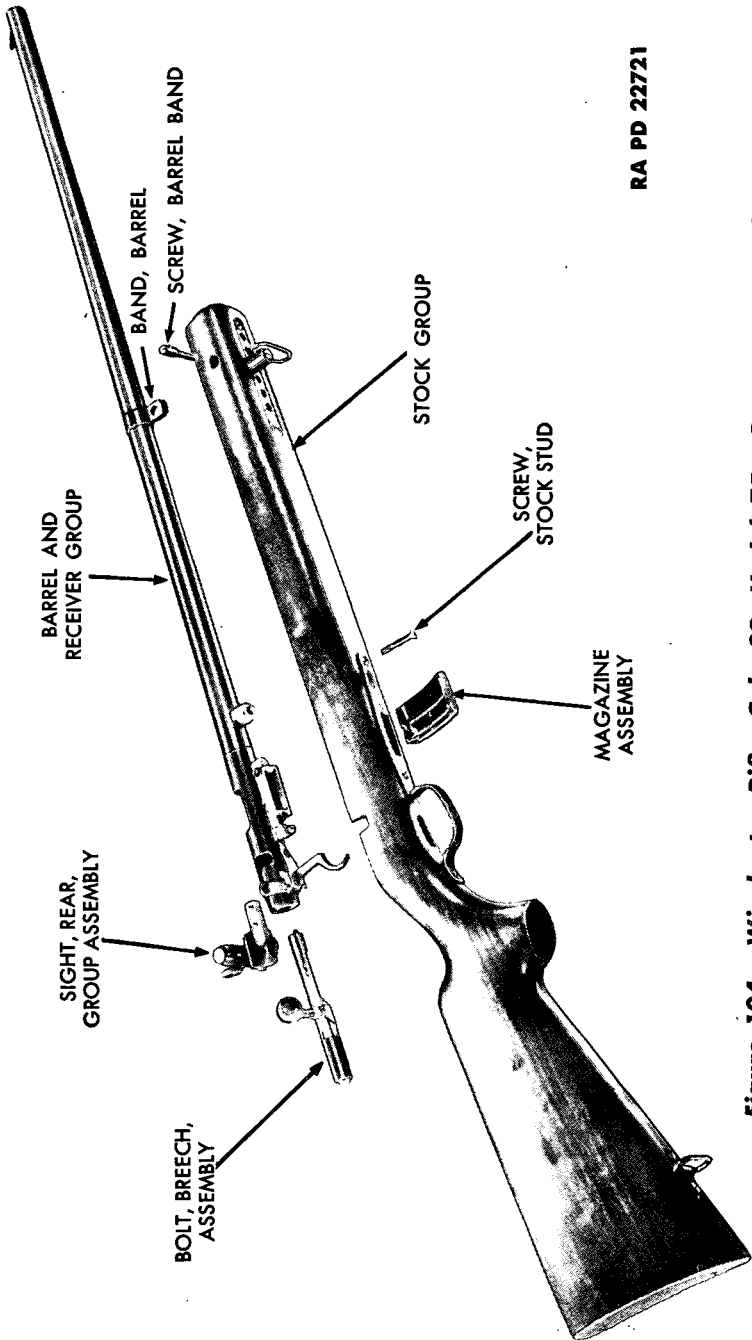

Figure 103 — Removing Barrel and Receiver Group From Stock Group of Stevens Rifle, Cal. .22, Model 416-2

DISASSEMBLY AND ASSEMBLY



RA PD 22721

Figure 104 — Winchester Rifle, Cal. .22, Model 75 — Groups Removed

CALIBER .22 RIFLES, ALL TYPES

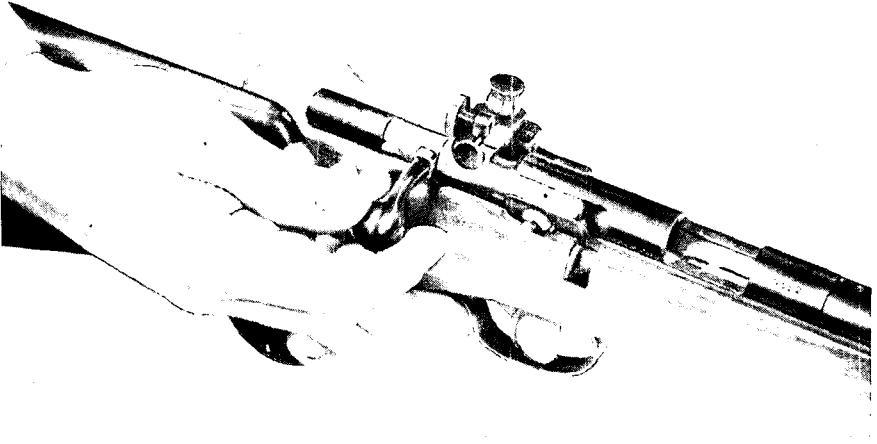

RA PD 81919

**Figure 105 – Removing Bolt From Winchester Rifle,
Cal. .22, Model 75**

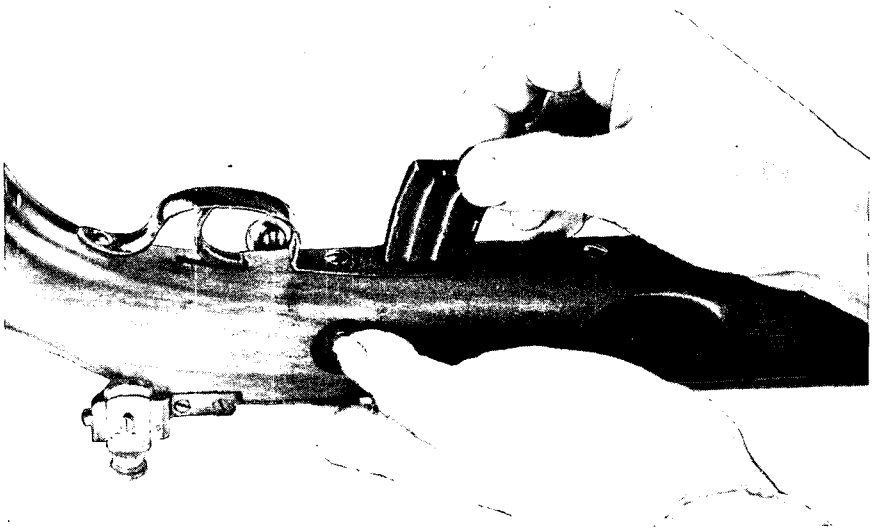

RA PD 81918

**Figure 106 – Removing Magazine From Winchester Rifle,
Cal. .22, Model 75**

DISASSEMBLY AND ASSEMBLY

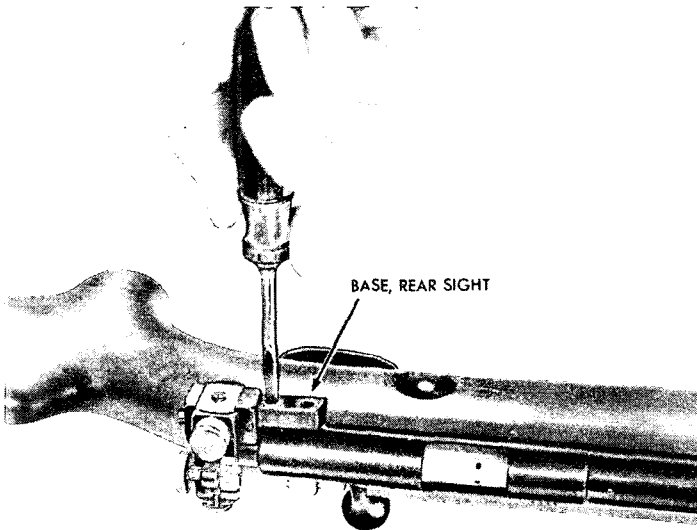

RA PD 81896

**Figure 107 – Removing Rear Sight From Winchester Rifle,
Cal. .22, Model 75**

and cock it by raising the bolt handle.) Depress the trigger until the bolt handle enters the slot in the receiver. Release the trigger and slide the bolt to its extreme forward position. Push the bolt handle down.

CAUTION: Be sure to release the trigger before sliding the bolt to its extreme forward position since it is cocked and might fire if pushed forward fast while the trigger is depressed.

b. Magazine Assembly.

(1) **REMOVAL.** Press in on the magazine release plunger located on the left side of the stock and pull the magazine out (fig. 106).

(2) **INSTALLATION.** Holding the convex side of the magazine assembly towards the rear of the rifle, slide the magazine into its recess until it seats and is locked in its proper position.

c. Rear Sight Group Assembly.

(1) **REMOVAL.** Unscrew the rear sight base screws holding the rear sight assembly to the rear sight base and remove the rear sight assembly (fig. 107).

(2) **INSTALLATION.** Place the rear sight assembly in its proper position on the receiver and secure it in place with the two rear sight base screws (fig. 107).

CALIBER .22 RIFLES, ALL TYPES

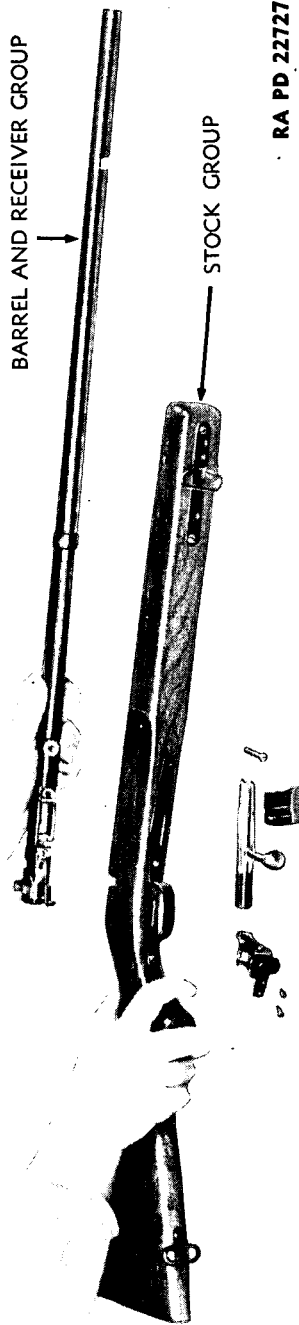

RA PD 22727

Figure 108 — Removing Barrel and Receiver Group From Stock Group of Winchester Rifle, Cal. .22, Model 175

DISASSEMBLY AND ASSEMBLY**d. Barrel and Receiver Group.**

(1) **REMOVAL.** Remove the barrel band screw, located on the side of the stock at the front swivel plate, and the stock stud screw located in the front guard hole. The barrel and receiver group can now be lifted from the stock (fig. 108).

(2) **INSTALLATION.**

(a) Place the barrel and receiver group in place in the stock (fig. 108).

CAUTION: If the rear sight has not been removed, keep the stock, as well as the barrel and receiver, flat against the bench so as not to damage the rear sight by hitting it against the bench.

(b) Insert and screw in the barrel band screw in the side of the stock at the front swivel plate and screw in the stock stud screw in the front guard hole.

CALIBER .22 RIFLES, ALL TYPES

CHAPTER 7
INSPECTION

54. GENERAL.

a. Inspection is for the purpose of determining the condition of the rifle and whether repairs or adjustments are required to insure its serviceability. Its immediate aim is trouble prevention which includes:

- (1) Preventive maintenance.
- (2) Discovering evidence of improper treatment received by the materiel before delivery into your hands.
- (3) Determining when replacement of parts is necessary because of ordinary wear or defects in parts.

b. Before inspection is started, the rifle should be fully unloaded, and thoroughly cleaned to remove any fouling, dirt, rust, or other foreign matter which might interfere with its proper functioning. For instructions in the care and cleaning as well as the materials to be used, refer to FM 23-10, TM 9-850, SNL K-1, and instructions contained in this manual.

c. Inspection of the assembled rifle consists of visual and functioning inspections. Checks are made on the trigger pull, rear sight, front sight, barrel and receiver group, stock group, bolt group, and the magazine group. Dummy cartridges are used to determine whether the rifle is functioning properly.

d. If the inspection determines that parts of assemblies are unserviceable, the entire assembly should be replaced. The using arms are not permitted to perform any disassembly other than removal of entire groups.

55. TOOLS FOR INSPECTION.

a. The tools and equipment required for inspection are the standard accessories described in chapter 9 with the addition of weights to determine trigger pull (par. 59).

56. BOLT GROUP.

a. Pull the bolt handle up and return it to the closed position to make sure the rifle cocks properly.

b. Pull the trigger to test action and see that the mainspring is in good condition and moves the firing pin forward properly (*CAUTION*, par. 5 a).

c. Load a fired cartridge case in the magazine and insert magazine in the receiver. Slowly retract the bolt and then slowly push it forward to see if it picks up the case properly from the magazine.

INSPECTION

(Do not try to load fired case into chamber as it may damage the chamber.) Then retract the bolt smartly to see if ejector throws the fired case clear of the receiver. Failure to pick up case or eject it indicates faulty extractions on ejector.

NOTE: This test is not a positive one as fired cartridge cases may be slightly deformed. *Testing with live ammunition is prohibited.*

d. Check extractors for looseness, burs, or worn claws. A fired cartridge case may be slid under the extractors to test retention.

e. Check ejector for looseness, deformation, and burs.

f. Inspect the bolt group for burs on all cams.

g. Check the operation of the safety.

h. Make sure the firing pin hole is not enlarged.

i. Make sure ejector stop functions properly (U.S. rifles).

NOTE: On the M1 and M2 Rifles, make sure the bolt sleeve lock is operating normally and seats properly in its notch in the bolt handle. On the M1, make sure that the bolt head latch functions properly.

57. MAGAZINE GROUP.

a. Check the magazine for fit and retention in the receiver.

b. Depress the magazine follower and note the smoothness of operation and tension of the spring.

c. Inspect the magazine for dents, cracks, deformed lips, and foreign matter.

d. Check the follower for deformation, wear, and burs, and the spring for set and deformation.

58. REAR SIGHT GROUP.

a. Try the rear sight elevating and windage knobs for tension.

b. Check the aperture for burs or looseness.

c. Make sure the elevating and windage scales are clear and readable.

d. Check for looseness of parts.

e. Inspect all parts for damage.

59. BARREL AND RECEIVER GROUP.

a. Check the front sight for looseness or damage.

b. With the bolt withdrawn, inspect the receiver for wear and burs in the ways, surfaces contacting moving parts, and cams.

c. The barrel is visually inspected by pointing the barrel and receiver towards the light and examining the bore from the muzzle to the breech. A piece of white paper placed in the breech will provide a reflecting surface. If the barrel is not bent, or otherwise deformed,

CALIBER .22 RIFLES, ALL TYPES

and the bore appears free from bulges and pits, and the lands are sharp and uniformly distinct, the barrel is serviceable. If the barrel contains a bulge, it is not serviceable and should be scrapped. This condition is indicated by a shadowy depression or dark ring in the bore. It may often be noticed through a bulge or exterior ring on the barrel after the rifle has been disassembled. If the barrel is pitted, it should be scrapped. This condition indicates that proper care of the barrel has not been taken. If the bore at the muzzle appears to be enlarged, improper cleaning is indicated, due to rubbing of the cleaning rod. Inspect the outside of the barrel for rust, dents, and burs.

d. The trigger, when pulled, should move to the rear without stopping or gritting. (For U.S. rifles, see paragraph 13 g.) Trigger pull of U.S. rifles must be greater than 3½ pounds but should not exceed 5 pounds. Rifles cleaned and repaired in ordnance establishments should have a minimum pull of not less than 4 pounds. Trigger pull is determined with proper weights attached to a wire having an L-shaped hook formed in the free end. Place the safety in the "ready" or "fire" position and cock the rifle. Have the weight resting on the floor or ground and hook the trigger weight wire onto the trigger so that pressure will be applied about one-fourth inch from the lower end of the trigger. Care should be taken to see that the wire contacts the trigger only and does not rub against the trigger guard or stock, and that the wire and the barrel are vertical and parallel, then, raise the weight from the floor as gently as possible. If the 3½-pound weight pulls the trigger (field test), or the 5-pound weight fails to pull the trigger, the rifle should be returned to ordnance personnel for correction.

NOTE: Trigger pull of commercial rifles should be between 4 and 6 pounds. Overhauled rifles should have a minimum pull of 4½ pounds to allow for wear. Test as above.

60. STOCK GROUP.

- a. Inspect the stock for cracks, scratches, bruises or mutilations.
- b. Check for loose or bent sling, swivels, burs, or loose screws.
- c. Check the seating of the butt plate. Make sure there are no loose or missing screws.
- d. Inspect trigger guard and floor plate or like part for loose screws, burs, or damaged parts.

61. SLINGS.

- a. Inspect the sling as a unit for appearance, general condition, flexibility, and function of hooks and sliding loops.
- b. Check the straps for condition of leather (M1907 Sling), weakness, ripped stitches, cuts, and abrasions. Check the hook holes for wear and breaks between holes. Check for tears at the rivets, and

INSPECTION

wear and cracking at the loops. The leather straps should not crack when bent at a sharp angle.

c. Check the hooks for deformation, pinching, and burs. Check the rivets for looseness. Check the loops for deformation and burs. Check the sliding loops for looseness on the straps, for pinching, and burs.

d. Check the M1 (Web) Sling for cut or frayed webbing of strap, and for positive retention of hook and keeper.

CALIBER .22 RIFLES, ALL TYPES

CHAPTER 8

AMMUNITION FOR RIFLE, CAL. .22, ALL TYPES

62. GENERAL.

a. Information in this chapter pertaining to type of cartridge authorized for use in the RIFLE, cal. .22, all types, includes a description of the cartridges, means of identification, care, use, and ballistic data.

63. NOMENCLATURE.

a. The cartridges described herein are listed in SNL T-1. Standard nomenclature is used in this manual whenever reference is made to specific items of issue. Its use for all purposes of record is mandatory.

64. FIRING TABLES.

a. Ballistic data are published herein in paragraph 73 and in TM 9-1990, and will not be published separately.

65. CLASSIFICATION.

a. The caliber .22 ammunition authorized for use in these rifles may be classified as ball cartridges of the long rifle type. The cartridges are known as rim fire cartridges because the priming composition is contained in a circular recess inside the rim of the cartridge case. Use of other than caliber .22 long rifle cartridge, issued by the Ordnance Department in these rifles, is prohibited.

66. IDENTIFICATION.

a. The caliber .22 long rifle cartridges are procured by the Ordnance Department from several commercial manufacturers. They are all of the same appearance (fig. 109) but differ slightly in shape of bullet, powder used, and ballistic qualities. The cartridge consists of the case, priming composition, powder charge, and bullet. The cartridge case is made of brass, copper, or gilding metal and is of the rim fire type. Cartridges of recent procurement may have steel, zinc-plated parkerized and oiled cases. The priming composition and charge of smokeless powder may differ for each manufacturer. Ammunition purchased since 1928 contains a noncorrosive primer composition. The bullet is made of lead.

b. Since all the cartridges for use in these rifles are of commercial design, they do not have any model designation. The manufacturer of these cartridges can be determined by the following marks which

AMMUNITION FOR RIFLE, CAL. .22, ALL TYPES

are stamped on the head of the case:

Federal cartridges have an initial "F."

Peters cartridges have an initial "P."

Remington cartridges have an initial "U."

United States Cartridge Co. cartridges have the initials "U.S."

Western cartridges have the figure of a diamond.

Winchester cartridges have an initial "H."

67. AMMUNITION LOT NUMBER.

a. Caliber .22 ammunition of recent manufacture has the manufacturer's lot number stamped on the wooden packing box, providing a means of identifying and reporting ammunition which may become defective.

68. GRADE.

a. No grade is assigned to caliber .22 ammunition. All unserviceable ammunition will be destroyed locally. Instructions for the destruction of ammunition are contained in TM 9-1900.

69. MARKING.

a. Packing cases are marked with the manufacturer's name, and the quantity and type of ammunition. Containers of this ammunition are usually marked by the manufacturer with the caliber, type of ammunition, type of powder, and such trade names as "Kleanbore," "Lubaloy," "Rustless," "Staynless," "Tackhole," "Filmkote," "Copperheads," etc. Boxes which do not have a metal liner for oversea shipments are stamped "NOT METAL LINED." (See paragraph 74.)

70. CARE, HANDLING, AND PRESERVATION.

a. Small-arms ammunition as compared with other types is not dangerous to handle. However, care must be observed to keep the wooden packing cases from becoming broken or damaged. All broken boxes must be immediately repaired and careful attention should be given that all markings are transferred to new parts of the box. In case the box contains a metal liner, it should be air-tested and sealed provided that equipment for this work is available.

b. Ammunition boxes should not be opened until the ammunition is required for use. Ammunition removed from its container, particularly in damp climates, is apt to corrode, thereby causing it to become unserviceable.

c. Protect ammunition carefully from mud, sand, dirt, and water. If it gets wet or dirty wipe it off at once. If verdigris or light corrosion forms on cartridges, it should be wiped off. However, cartridges should not be polished to make them look better or brighter.

d. Use of oil or grease on cartridges other than that applied by the manufacturer is prohibited.

e. Do not fire cartridges with loose bullets or otherwise defective rounds.

CALIBER .22 RIFLES, ALL TYPES

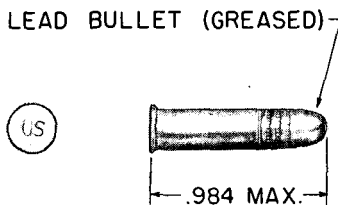

RA PD 4311

Figure 109 – CARTRIDGE, Ball, Cal. .22, Long Rifle



RA PD 69114

Figure 110 – Erosion Caused by Firing Cal. .22 Short Cartridges in a Barrel Chambered for a Cal. .22 Long Rifle Cartridge

f. Do not allow ammunition to be exposed to direct rays of the sun for any length of time. This is likely to affect its firing qualities.

g. Whenever cartridges are taken from original packing container, they will be tagged so that in the event ammunition is not fired it can later be identified and returned to its proper packing box.

71. STORAGE.

a. Whenever practicable, small-arms ammunition should be stored under cover. When necessary to leave it in the open, raise it on dunnage at least 6 inches from the ground, and cover it with a double thickness of paulin. Suitable trenches should be dug to prevent water flowing under the pile.

72. AUTHORIZED ROUND.

a. The ammunition listed below is authorized for use in the RIFLE, cal. .22, all types. It should be noted that this nomenclature completely describes the cartridge as to type, caliber, and model. For authorized use in training, see AR 775-10.

CARTRIDGE, ball, caliber .22, long rifle

b. Use of caliber .22 short cartridge or other than caliber .22 long rifle cartridge (fig. 109) is prohibited in these rifles. Such cartridges will be inaccurate and damage the rifle by causing erosion which will cause the rifle to function unsatisfactorily with its standard cartridge. Figure 110 shows results brought about by use of a shorter cartridge than that for which the rifle was designed. Commercial manufacturers have brought out cartridges of the long rifle type known as Hi-Speed, Hi-Victory, Super Speed, etc., which give high muzzle

AMMUNITION FOR RIFLE, CAL. .22, ALL TYPES

velocities and create high pressures. These high velocity cartridges are not issued by the Ordnance Department nor is their use recommended.

73. DATA.

a. Although there are slight differences in cartridges of different manufacture (shape of bullet, powder, etc.), the following data are considered substantially correct.

b. General.

Muzzle velocity (approx.) 1,100 ft per sec
 Maximum range at approximately 30-degree elevation 1,500 yd
 Pressure in chamber (approx.) 16,000 lb per sq in.
 Weight of ball cartridge (approx.) 53.5 grains
 Weight of bullet (approx.) 40.0 grains
 Weight of powder charge (approx.) 1.7 grains

c. Table of Fire.

Range (yd)	Velocity (ft-sec)	Bullet Energy (ft-lb)	Time of Flight (sec)	Drop at Target (in.)	Ordinate of Trajectory Half Range (in.)	Mean Accuracy Radius (in.)	Angle of Departure (min)
0	1,100	102					
25	1,070	95	0.068	0.89	0.24	0.14	3.5
50	1,020	89	0.140	3.17	0.98	0.33	7.6
75	980	84	0.214	8.06	2.28	0.45	11.7
100	950	79	0.292	14.82	4.08	0.57	15.8
125	920	75	0.372	24.73	6.78	0.80	20.5
150	890	71	0.455	36.64	10.02	0.98	24.9
175	860	67	0.541	50.80	14.20	1.13	29.6
200	840	64	0.630	72.93	19.10	1.25	34.3
225	810	61	0.720	93.04	28.30	1.45	39.7
250	790	58	0.812	118.21	31.87	1.65	44.7
275	770	55	0.911	147.20	39.87	1.88	50.8
300	750	52	1.005	177.12	48.69	2.12	55.7

d. Angles of Departure.

Range (yd)	Angle of Departure		Range (yd)	Angle of Departure	
	Degrees	Minutes		Degrees	Minutes
100		16	900	6	13
200		34	1,000	7	44
300		56	1,100	9	32
400	1	29	1,200	11	41
500	2	10	1,300	14	16
600	2	56	1,400	19	00
700	3	51	1,450	25	00
800	4	56			

CALIBER .22 RIFLES, ALL TYPES

e. Accuracy (as Determined by Firings to Date).

Range (yd)	Diameter of Group Circle (in.)
25	0.5
50	1.0
100	3.0
200	8.0

f. Elevation and Windage Changes. The rear sight elevating screw knob of the U.S. rifles has 10 graduations. A click or half minute of angle corresponds to one graduation; a change of one graduation on this knob changes the point of impact vertically 0.5 inch at 100 yards. A click of the rear sight windage screw knob will change point of impact 0.5 inch horizontally at 100 yards. Changes in point of impact corresponding to one click of the rear sight windage screw knob or one click of the rear sight elevating screw knob at ranges from 50 to 200 yards are shown in the table below.

Range	Change at Point of Impact (in.)
50 feet	0.08
25 yards	0.125
50 yards	0.25
100 yards	0.50
200 yards	1.00

g. Penetration. When fired into 1-inch pine boards spaced 1 inch apart at a range of 15 feet, the bullet will penetrate the first five boards and one-eighth inch into the sixth board.

74. PACKING.

a. The cartridges are packed 50 in a cardboard box and 10 of these boxes (500 cartridges) are packed in a paper carton. The outside wooden packing cases contain either 5,000 or 10,000 cartridges, 10 or 20 cartons, respectively. Boxes of this ammunition procured for oversea shipment have an airtight metal liner.

b. A case of 10,000 cartridges without metal liner weighs 85 pounds. Additional data are published in SNL T-1.

75. FIELD REPORT OF ACCIDENTS.

a. When an accident involving the use of ammunition occurs during training practice, the procedure prescribed in AR 750-10 will be observed by the ordnance officer under whose supervision the ammunition is maintained or issued. Where practicable, reports covering malfunctions of ammunition in combat will be made to the Chief of Ordnance, giving the type of malfunction, type of ammunition, the lot number of the complete rounds or separate-loading components, and conditions under which fired.

CHAPTER 9

ORGANIZATIONAL SPARE PARTS AND ACCESSORIES

76. ORGANIZATIONAL SPARE PARTS.

a. A set of spare parts is supplied to the using arms for field replacement of those parts most likely to become broken, worn, or otherwise unserviceable. The set should be kept complete at all times by requisitioning new parts for those used. After it has been received, try each part as soon as practicable, to see that it fits the materiel properly. Replace any parts which do not function properly. For listing of organizational spare parts for the U.S. Rifles, Cal. .22, M1922, M1, and M2, see SNL B-17.

b. Organizational spare parts will not be furnished for the caliber .22 rifles (commercial). When these rifles become unserviceable, they should be shipped to an arsenal for repair.

c. Spare parts should be kept clean and well oiled for preservation at all times. Sets of parts should be checked occasionally for completeness, and when a spare part is used, another should be requisitioned to complete the set.

77. ACCESSORIES.

a. Accessories include the tools and equipment required for such disassembly and assembly as the using arms are authorized to perform, and for cleaning and preserving the rifles. Accessories should not be used for purposes other than those prescribed, and when not in use should be properly stored.

b. There are a number of accessories, the names or general characteristics of which indicate their use. Others, embodying special features or having special uses, are described in the following paragraphs:

(1) **CLEANING BRUSH, CAL. .22, M3.** This is a bronze bristle brush (fig. 111) 1½ inches in over-all length. It consists of the core and bristles. The core made of brass wire is twisted in a spiral and holds the bristles in place.

(2) **CLEANING ROD, CAL. .22, M1.** The rod (fig. 112) consists of a rod, handle, washer, collar, and pin. The cleaning rod is constructed of steel, and is of sufficient length so that the bore of the rifle can be cleaned from the breech end. The handle swivels on the rod between the washer and collar.

(3) **FRONT SIGHT COVER.** This cover (fig. 113) is made of sheet steel and pressed into shape. It is then case-hardened, giving it sufficient spring to cause it to hug closely the barrel and front sight stud, thereby retaining its position on the barrel. This cover is for use with the U.S. rifles only.

CALIBER .22 RIFLES, ALL TYPES

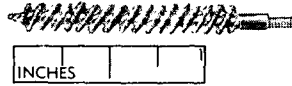

RA PD 85531

Figure 111 – Cleaning Brush, Cal. .22, M3, C64179

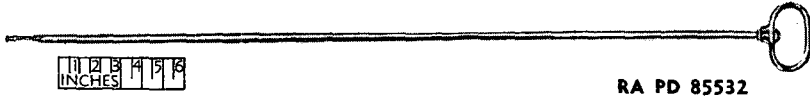

RA PD 85532

Figure 112 – Cleaning Rod, Cal. .22, M1, C3837



RA PD 85536

Figure 113 – Front Sight Cover, C64157

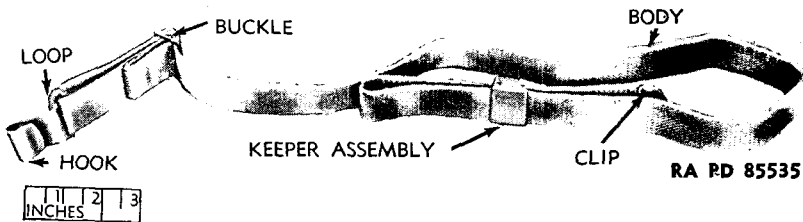

RA PD 85535

Figure 114 – Gun Sling M1, D44058

(4) GUN SLING M1. The gun sling (fig. 114) is comprised of three assemblies; the sling assembly, consisting of a cotton webbing body to which is fastened a clip and buckle; a keeper assembly, composed of a keeper body and clamp; and a hook assembly, which consists of a hook and loop. To attach the gun sling to the rifle, pass the clip end of the sling assembly through the lower band (or forward) swivel and fasten securely with the keeper assembly. Clip the hook assembly to the butt swivel. The gun sling fastened to the rifle loops in this manner is then adjusted to suit the particular soldier using it. If additional adjustment is needed, remove the forward swivel (commercial rifles) and insert into the proper adjustment hole.

ORGANIZATIONAL SPARE PARTS AND ACCESSORIES

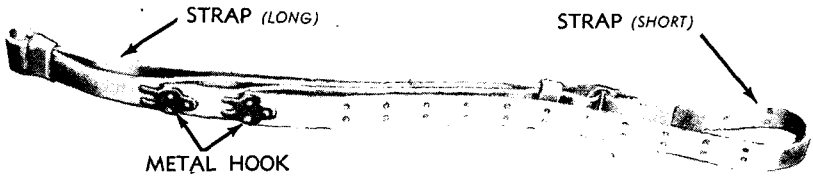

RA PD 85534

Figure 115 – Gun Sling M1907 (Leather), 20-18-25

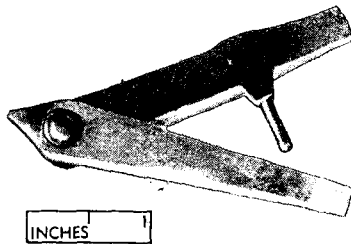

RA PD 85537

Figure 116 – Rifle Screwdriver, C64038

(5) **GUN SLING M1907 (LEATHER).** This sling (fig. 115) consists of a long leather strap and a short leather strap joined together by a metal loop. On one end of each of these straps is a metal hook fastened to the strap with rivets. In order to obtain the proper adjustment of the gun sling, the hooks are inserted into holes which are provided in the long and short straps for this purpose. The sliding loops which are made of leather serve to keep the leather strap loop in position on the rifleman's arm after proper adjustment has been made to the gun sling.

(6) **RIFLE SCREWDRIVER.** This screwdriver (fig. 116) consists of two blades and a punch pin fastened together by a rivet, making a combination tool used in disassembling and assembling the rifle.

CALIBER .22 RIFLES, ALL TYPES

CHAPTER 10

STORAGE AND SHIPMENT

78. PREPARATION FOR RAIL SHIPMENT.

a. List of Material Required for Preparation of Target Rifles for Shipment and Storage.

CLOTH, abrasive, aluminum-oxide	SOAP, castile
CLOTH, crocus	SOLVENT, dry-cleaning
OIL, lubricating, preservative, medium	

b. Cleaning.

(1) Disassembly of the rifles shall be made in accordance with procedure outlined in chapter 6.

(2) Clean all metal parts, including metal parts of stock, trigger mechanism, bolt group, rear sight group, magazine group, safety parts, and front sight group thoroughly with dry-cleaning solvent or with a soap solution as follows:

(a) Apply dry-cleaning solvent by scrubbing with a brush or wiping with a clean, saturated cloth.

(b) Apply soap solution consisting of 1 pound of castile soap to 4 gallons of water, by vigorously brushing or scrubbing the surfaces thoroughly until all traces of contamination have been removed. The surfaces shall then be rinsed with clean, hot water and dried thoroughly.

(3) Avoid contact of bare hands with the cleaned surfaces.

(4) REMOVING RUST SPOTS. If rust has formed on surfaces of the materiel, rust should be removed in accordance with the following:

(a) Use aluminum-oxide abrasive cloth for cleaning finished and unfinished external surfaces where wear of the parts cleaned will not affect the functioning of the mechanism.

(b) Use crocus cloth for removing rust or stain and polishing parts of the firing mechanism and other finished surfaces of metal.

c. Preservation of Materiel. *CAUTION: Application of preservative shall be performed immediately after cleaning.*

(1) Completely cover all metal parts of rifles with medium preservative lubricating oil.

(2) Special care must be taken when assembling parts so as not to rub off any of the preservative applied.

(3) If tank is available, dipping of assembled rifles shall be done at a 45-degree angle with bolt retracted to prevent an air void.

(4) Allow excess oil to drain from rifles, close bolt, and release hammer by pulling trigger before wrapping and boxing.

STORAGE AND SHIPMENT

d. Shipping Containers.

(1) CHEST SPECIFICATIONS (10 RIFLES PER ARMS CHEST).

	L	W	H	Wt.
U.S. Rifle, Cal. .22, M1922MI and M2	4.83	1.21	1.25	165 lb gross
U.S. Rifle, Cal. .22, Remington, Model 513T	4.15	1.33	1.04	135 lb gross
U.S. Rifle, Cal. .22, Stevens, Model 416-2	4.15	1.33	1.04	142 lb gross
U.S. Rifle, Cal. .22, Winchester, Model 75	4.15	1.33	1.04	130 lb gross

NOTE: Refer to SB 9-OSSC B for additional data on shipping and storage.

79. REMOVAL OF PRESERVATIVE MATERIAL.

a. The procedure for the preparation of materiel upon arrival at destination, if materiel is to be placed in service or upon removal from storage, is accomplished as prescribed in paragraph 78 b.

b. Lubricate rifles thoroughly in accordance with lubrication instructions, paragraph 78.

80. LIMITED STORAGE INSTRUCTIONS.

a. **Limited Storage (Periods Less Than 30 Days).** Materiel in limited storage is that materiel which is temporarily out of service for less than 30 days, or materiel that must be ready for operation on call.

(1) **PREPARATION.** Before being stored, materiel will be thoroughly cleaned and completely rust-proofed as prescribed in paragraph 78 b and c.

(2) **INSPECTIONS.** Periodical inspections should be made of the materiel while in storage. This inspection should note, among other things, condition of the rust-preventives, the missing parts, and the need for repairs. If found to be corroding at any part, the materiel should be completely rust-proofed and preserved as prescribed in paragraph 78 b and c.

CALIBER .22 RIFLES, ALL TYPES

CHAPTER 11

OPERATION UNDER UNUSUAL CONDITIONS

81. HOT CLIMATES.

a. Hot, Humid Climates.

(1) In tropical climates where temperature and humidity are high, or where salt air is present, and during rainy seasons, the rifle should be thoroughly inspected daily and kept lightly oiled when not in use. The groups should be dismantled at regular intervals and, if necessary, disassembled sufficiently to permit drying and oiling the parts.

(2) Care should be exercised to see that unexposed parts and surfaces are kept clean and oiled.

(3) OIL, lubricating, preservative, medium, should be used for lubrication.

(4) Wood parts should be inspected to see that swelling due to moisture does not bind working parts; if necessary, shave off the wood but only enough to relieve binding. A light coat of OIL, linseed, raw, applied monthly, and well rubbed in with the heel of the hand, will help to keep moisture out. Allow the oil to soak in for a few hours and then wipe and polish the wood with a dry, clean rag. (Linseed oil should not be used on varnished stocks.)

CAUTION: Care should be taken that linseed oil does not get into the mechanism or on metal parts as it will become gummy when dry. Stock should be dismantled when this oil is applied.

b. Hot, Dry Climates.

(1) In hot, dry climates, where sand and dust are apt to get into the mechanism and bore, the rifle should be wiped clean daily, or oftener, if necessary. Groups should be dismantled and disassembled as far as necessary to facilitate thorough cleaning.

(2) In such climates, wood parts are likely to dry out and shrink. A light application of raw linseed oil applied as in subparagraph (4), above, will help to keep the wood in condition.

(3) Oiling and lubrication should be kept to a minimum, as oil will collect dust which will act as an abrasive on the working parts and foul the bore and chamber. OIL, lubricating, preservative, special, is best for lubrication where temperatures are high, and should be lightly applied only to the surfaces of working parts showing signs of wear.

(4) Perspiration from the hands is usually acid and causes rust. Metal parts should, therefore, frequently be wiped dry.

(5) During sand or dust storms the rifle should be kept covered if possible.

OPERATION UNDER UNUSUAL CONDITIONS**82. COLD CLIMATES.**

a. In temperatures below freezing, and particularly in Arctic climates, it is necessary that the moving parts of the rifle be kept absolutely free of moisture. It has also been found that excess oil on the working parts will solidify to such an extent in cold weather as to cause sluggish operation or complete failure of the rifle.

b. In temperatures below 0 F, the metal parts of the rifle should be taken apart and completely cleaned with SOLVENT, dry-cleaning, before use. The solvent should then be thoroughly wiped off, and when thoroughly dry, parts should be immediately oiled with OIL, lubricating, preservative, special, and the oil then wiped off with a clean cloth. The working surfaces of parts which show signs of wear may be lubricated by rubbing with an oiled cloth. At temperatures above 0 F, the rifle may be oiled lightly after cleaning by wiping with a slightly oiled cloth, using OIL, lubricating, preservative, special.

c. Immediately upon being brought indoors, the rifle should be thoroughly oiled, using OIL, lubricating, preservative, special, because moisture condensing on the cold metal in a warm room will cause rusting. After the rifle has reached room temperature, it should be wiped free of condensed water vapor and oiled again.

d. If the rifle has been fired, it should be thoroughly cleaned and oiled. The bore may be swabbed out with an oiled patch and, when the rifle reaches room temperature, thoroughly cleaned with CLEANER, rifle bore, and oiled as prescribed in subparagraph b, above.

e. Before firing, the rifle should be cleaned and oil should be removed as prescribed in subparagraph b, above. The bore and chamber should be entirely free of oil before firing.

NOTE: If possible, condensation should be avoided by providing a cold place in which to keep rifles when not in use. For example, a separate cold room with appropriate racks may be used or, when in the field, racks under proper cover may be set up outdoors.

CALIBER .22 RIFLES, ALL TYPES

CHAPTER 12
REFERENCES

83. PUBLICATIONS INDEXES.

The following publications indexes should be consulted frequently for latest changes or revisions of references given in this chapter and for new publications relating to materiel covered in this manual:

- a. Introduction to Ordnance Catalog (explaining SNL system) ASF Cat. ORD 1 IOC
- b. Ordnance Publications for Supply Index (index to SNL's) ASF Cat. ORD 2 OPSI
- c. Index to Ordnance Publications (listing FM's, TM's, TC's, and TB's of interest to ordnance personnel, OPSR's, MWO's, BSD, S of SR's, OSSC's, and OFSB's; and includes Alphabetical List of Major Items with Publications Pertaining Thereto) OFSB 1-1
- d. List of Publications for Training (listing MR's, MTP's, T/BA's, T/A's, FM's, TM's, and TR's concerning training) FM 21-6
- e. List of Training Films, Film Strips, and Film Bulletins (listing TF's, FS's, and FB's by serial number and subject) FM 21-7
- f. Military Training Aids (listing Graphic Training Aids, Models, Devices, and Displays) FM 21-8

84. STANDARD NOMENCLATURE LISTS.

- a. **Cleaning and Preserving.**
Cleaning, preserving and lubricating materials; recoil fluids, special oils, and miscellaneous related items SNL K-1
- b. **Gun Materiel.**
Ammunition, rifle, carbine, and automatic gun Packing materials used by field service for small-arms service ammunition SNL T-5
Rifles, U.S. cal. .22, M1922, M1922MI, and M2 Rifles, cal. .22, (commercial) SNL B-17
SNL B-25

85. EXPLANATORY PUBLICATIONS.

- a. **Gun Materiel.**
Ammunition, general TM 9-1900
Ordnance maintenance: Rifles, Cal. .22, All types TM 9-1280

REFERENCES

- Qualifications in arms and ammunition training allowances AR 775-10
- Small arms ammunition TM 9-1990
- Small arms ammunition OFSB 3-5
- b. Inspection, Maintenance, and Lubrication.**
 - Cleaning, preserving, lubricating, and welding materials and similar items issued by the Ordnance Department TM 9-850
 - General lubrication instructions, small arms ... OFSB 6-3
 - Serviceability standards OFSB 4-17
- c. Instruction guide: Small arms accidents, malfunctions, and their causes TM 9-2210**
- d. Rifle Practice, Targets, and Ranges.**
 - Range regulations for firing ammunition for training and target practice AR 750-10
 - Targets, target materials, and rifle range construction TM 9-855
- e. Instruction guide: Small arms, light field mortars and 20-mm aircraft guns TM 9-2200**
- f. Small arms, hand arms, semiautomatic rifles, pyrotechnic projectors, scabbards, and arm chests, arm lockers, and arm racks SB 9-OSSC B**

CALIBER .22 RIFLES, ALL TYPES

INDEX

A	Page	Page	
Accessories	131	(See also Bolt with firing mechanism assembly (U.S. rifles))	
Accidents (ammunition), field report of	130		
Ammunition		Bolt handle and body group	
authorized round	128	(Stevens rifle)	55
care, handling, and preservation	127	Bolt handle groups	
cautions in use of	14	Remington rifle	45
classification, identification, and nomenclature	126	Stevens rifle	55
data	129	U.S. rifles	22, 26
firing tables	126	Bolt head groups	
lot number, grade, and marking	127	Stevens rifle	54
packing and field report of accidents	130	U.S. rifles	18
storage	128	Bolt sleeve assemblies	
Anti-aircraft rear sight aperture, installation and removal	103	Remington rifle	46
Assembly (See Disassembly and assembly)		U.S. rifles	27
		Winchester rifle	
		bolt cocking sleeve	69
		bolt sleeve	72
		Bolt with firing mechanism assembly (U.S. rifles)	
		description and functioning	18
		removal and installation	99
		Bore, cleaning of	94, 95
		Butt plate and swivel (U.S. rifles)	39
		C	
Barrel and receiver group		Care and preservation	
description and functioning		ammunition	127
Remington rifle	50	cautions	14
Stevens rifle	63	removal of preservative material	135
U.S. rifles	34	rifles	93
Winchester rifle	77	Cartridge, ball, cal. .22, long rifle	128
inspection	123	Cartridges, cautions in use of	14
removal and installation		Case, split, stretched, or ruptured	92
Remington rifle	110	Cleaning	
Stevens rifle	115	during and after firing	95
U.S. rifles	108	preparatory to firing	94
Winchester rifle	121	rifles received from storage	96
Blowback	92	when no firing is done	94
Bolt groups		Cleaning brush, cal. .22, M3	131
assembly of bolt (U.S. rifles)	102	Cleaning rod, cal. .22, M1	131
description and functioning		Cocking the rifles (recocking)	86
Remington rifle	44		
Stevens rifle	54	D	
Winchester rifles	69	Data	13
disassembly of bolt (U.S. rifles)	99	Disassembly and assembly	
inspection	122	general discussion	99
removal and installation		Remington rifle	108
Remington rifle	108		
Stevens rifle	111		
Winchester rifle	115		

INDEX

D—Contd.	Page	I	Page
Disassembly and assembly—Contd.		Inspection	
Stevens rifle	111	barrel and receiver group	123
U.S. rifles	99	bolt group	122
Winchester rifle	115	general discussion	122
		magazine group	123
E		rear sight group	123
Ejector		stock group and slings	124
differences among rifle models	13	tools	122
failure to eject	92		
Remington rifle	51	L	
to obtain positive ejection	14	Loading rifles	10
U.S. rifles	20	Lot number, ammunition	127
Winchester rifle	80	Lubrication	97
Elevation and windage changes	130	Lyman 48C receiver sight	32, 87
Extractor		Lyman 57E rear sight	75
failure to extract	92		
U.S. rifles	20	M	
		Magazine	
F		failure to feed from	92
Feed, failure to	92	loading	84
Firing		retaining spring (U.S. rifles)	37
accuracy	130	Magazine group	
cautions	14, 41	description and functioning	
failure to fire	92	Remington rifle	47
firing	86	Stevens rifle	59
table of fire	129	U.S. rifles	31
(See also Cleaning)		Winchester rifle	75
Firing mechanism group		inspection	123
Stevens rifle	55	removal and installation	
U.S. rifles	28	Remington rifle	108
Firing pin group		Stevens rifle	111, 114
Remington rifle	46	U.S. rifles	103
U.S. rifles	28	Winchester rifle	119
Winchester rifle	73	Magazine housing group	
Firing tables	126	Stevens rifle	67
Floor plate (U.S. rifles)	39	Winchester rifle	80
		Magazine lock (Remington rifle)	51
G		Malfunctions and corrections	91, 92
Gun sling M1	132	Marking ammunition	127
Gun sling M1907 (leather)		Metal surfaces, cleaning of	94
cleaning	94	Misfires	14, 91
description	133	Models (rifle), differences among	10
Gun slings, inspection of	124		
		N	
H		Nomenclature	
Handle group, bolt (See Bolt handle group)		ammunition	126
Handling ammunition	127	parts and assemblies	15
Hangfire	92		

CALIBER .22 RIFLES, ALL TYPES

O	Page	Page	
Oiling	94	functioning	68
Operation		magazine and rear sight assem-	
cold climates	137	blies	59
firing and recocking	86	rear sight setting	
hot climates	136	rear sights	86, 88
loading the rifle or magazine	84	zeroing the sights	90
rear sight setting	86	setting the safety	86
setting the safety	84	stock group	67
		Rifle, Winchester model 75	
P		assembly and disassembly	115
Packing ammunition	130	barrel and receiver group	77
Penetration of bullet	130	breech bolt assembly	69
		characteristics and data	13
R		comparison of commercial rifles	12
Rail shipment	134	functioning	82
Receiver		magazine and rear sight assem-	
Remington rifle	51	blies	75
Stevens rifle	63	rear sight setting	
U.S. rifles	36	rear sights	86, 88
Winchester rifle	79	zeroing the sights	90
(See also Barrel and receiver		setting the safety	86
group)		stock group	80
Receiver group (and barrel) (See		Rifle M1922, U.S., differences	
Barrel and receiver group)		among models	10
Redfield 75 RT sight	47, 87	Rifles M1 and M2, U.S.	
Repair, explanation of	91	assembly and disassembly	99
Rifle, Remington model 513 T		barrel and receiver group	34
assembly and disassembly	108	bolt with firing mechanism	
barrel and receiver group	50	assembly	18
bolt group	44	characteristics and data	13
characteristics and data	13	differences among models	11
comparison of commercial rifles	12	magazine assembly	31
differences from U.S. rifles	41	operation and functioning	18, 40
functioning	53	rear sight group	32
magazine and rear sight assem-		rear sight setting	
bly	47	rear sights	86, 87
rear sight setting		zeroing the sights	89
rear sights	86, 87	setting the safety	84
zeroing the sights	89	stock group	39
setting the safety	86	Rifles (cal. .22)	
stock group	53	characteristics and differences	
Rifle, Stevens model 416-2		among models	10, 13
assembly and disassembly	111	cleaning	
barrel and receiver group	63	after and during firing	95
bolt assembly	54	rifles received from storage	96
characteristics and data	13	when no firing is done	93
comparison of commercial rifles	12	description	15
differences from U.S. rifle	54	disassembly (general discussion)	15
		firing and recocking	86
		loading	84

INDEX

R—Contd.	Page		Page
Rifles (commercial), differences among models	12	Spring (U.S. rifles), magazine retaining	37
Rust preventive	94	Stock group	
S			
Safety group		cleaning	93
Stevens rifle	67	inspection	124
Winchester rifle	80	Remington rifle	53
Safety lock		Stevens rifle	67
description and functioning ..	28	U.S. rifles	39
Remington rifle	51	Winchester rifle	80
setting the safety	84	Stoppage, cautions in case of ...	14
Screwdriver, rifle	133	Storage and shipment	
Shipment (See Storage and shipment)		ammunition storage	128
Sight assembly, rear		cleaning rifles received from storage	96
description and functioning		limited storage	135
Remington rifle	47	rail shipment	134
Stevens rifle	59	removal of preservative material ..	135
U.S. rifles	32	T	
Winchester rifle	75	Tools, for inspection	122
inspection	123	Trigger	
removal and installation		cautions in use of	14
Remington rifle	108, 110	functioning	
Stevens rifle	114	Remington rifle	54
U.S. rifles	103	Stevens rifle	69
Winchester rifle	119	U.S. rifles	41
Sight cover, front	131	Trigger mechanism group	
Sights		Remington rifle	51
characteristics of rear sight ..	10	Stevens rifle	65
differences among rifle models ..	13	U.S. rifles	36
front sight		Winchester rifle	79
Remington rifle	51	Trigger pull, differences among rifle models	13
U.S. rifles	36	W	
rear sight		Windage and elevation changes ..	130
setting	86	Wood parts, cleaning	93
U.S. rifles	32	Z	
zeroing	88	Zeroing the rear sights	88
Sleeve group, bolt (See Bolt sleeve assembly)			
Sling, gun (See Gun sling)			
Spare parts	15, 131		